

RADIO'S LIVEST MAGAZINE



December  
25 Cents

# Radio-Craft

for the  
Professional-Serviceman-Radiotrician

HUGO GERNSBACK Editor



Do Your Own  
**HOME RECORDING**

See Page 340

Why Modern Radio Servicing  
Grows More Complex  
By John E. Rider

The Newest Developments in  
Radio and Television  
Remote-Control for Receivers

Up-to-Date Short Wave Design  
The Superheterodyne of Today  
A Direct-Coupled '45 Amplifier

-ROMAINE-



# Lowest WHOLESALE Prices on Everything in RADIO



## Consolette Screen Grid Radio Set

A complete 5 tube  
A. C. Receiver, with  
Radiola Speaker, in  
a 13x18 inch beautiful  
walnut cabinet.

**SALE PRICE  
ONLY**  
**\$29<sup>50</sup>**

We have slashed all our Radio prices to keep pace with this buyers' market. The world's largest Radio Store buys in such large quantities that it can afford to pass along to you the marvelous price-savings offered in this catalog. We urge every radio user to supply his needs while these short-time Lowest Wholesale Prices are in effect.

## All the 1931 Improvements!

Our immense stock is complete with practically everything in Radio, and all the latest 1931 features are listed in this cut-sale catalog. New Humless, Screen Grid A. C. all-electric and battery operated sets; a wide range of beautiful and artistic consoles; dynamic speakers and phono-combinations; electric clock and slot machine sets; tubes, parts and all manner of accessories—all are now offered at almost unbelievable prices.

Cash talks in this market, and we scoured the radio manufacturing field to secure the bargain exhibit listed in our second big-sale offering. We are known as the lowest priced of all reliable radio houses, but we frankly state that never before have we been able to offer our thousands of customers such values in standard sets and parts.

Send this **COUPON** for  
**CATALOG**

Chicago Salvage Stock Store,  
Dept. 645,  
509 So. State St., Chicago, Ill.  
Kindly send me (free of charge and postpaid)  
your new Book of Radio Bargains.

Name .....

Address .....

State .....

City .....

## Startling Values in Sets — Parts — Kits and Accessories

All the standard sets and equipment are offered at a mere fraction of their regular selling prices. We not only give you the benefit of *Wholesale* prices—but of the *LOWEST* Wholesale Price. All orders given careful and prompt attention. Send today for this Catalog of smashing bargains. Use the coupon.

**CHICAGO SALVAGE STOCK STORE**  
**World's Largest Radio Store**  
**509 So. State St. Dept. 645 Chicago, Ill.**

The Place to  
Save Money On  
**RADIO**





**We Could Have Placed 5000 More Qualified Men Last Year in Good Pay RADIO Positions**

**G**ET into the rich field of Radio via the training school that supplies big Radio employers with their new men! The Radio Training Association of America has a standing order from radio trade organizations, large manufacturers and dealers, for members qualified for full time work at splendid pay.

So great is this demand from Radio employers that positions offering good pay and real opportunity are going begging. If you want to cash in on Radio quick, earn \$3.00 an hour and up spare time, \$40 to \$100 a week full time, prepare for a \$10,000, \$15,000, \$25,000 a year Radio position, investigate the R. T. A. now.

**Special Attention to Radio Service Work**

Thousands of trained Radio Service Men are needed now to service the new all-electric sets. Pay is liberal, promotions rapid. The experience you receive fits you for the biggest jobs in Radio. The R. T. A. has arranged its course to enable you to cash in on this work within 30 days!

Would you like to work "behind the scenes" at Hollywood, or for a talking picture manufacturer? R. T. A. training qualifies you for this work. Television, too, is included in the training. When television begins to sweep over the country, R. T. A. men will be ready to cash in on the big pay jobs that will be created.

**Expert Supervision Lifelong Consultation Service**

As a member of the Association you will receive personal instruction from skilled Radio Engineers. Under their friendly guidance every phase of Radio will become an open book to you. And after you graduate the R. T. A. Advisory Board will give you personal advice on any problems which arise in your work. This Board is made up of big men in the industry who are helping constantly to push R. T. A. men to the top.

Because R. T. A. training is complete, up-to-date, practical, it has won the admiration of the Radio industry. That's why our members are in such demand—why you will find enrolling in R. T. A. the quickest, most profitable route to Radio.

**Mail Coupon for No-Cost Training Offer**

Memberships that need not—should not—cost you a cent are available right now. The minute it takes to fill out coupon at right for details can result in your doubling and trebling your income in a few months from now. If you are ambitious, really want to get somewhere in life, you owe it to yourself to investigate. Learn what the R. T. A. has done for thousands—and can do for you. Stop wishing and start *actually doing something* about earning more money. Fill out the coupon and mail today.

**Radio Training Association of America  
Dept. RCA-12 4513 Ravenswood Ave., Chicago, Ill.**

**Fill Out and Mail Today!**

**RADIO TRAINING ASSOCIATION OF AMERICA**  
Dept. RCA 12 4513 Ravenswood Ave., Chicago, Ill.

Gentlemen: Send me details of your No-Cost Training Offer and information on how to make real money in Radio quick.

Name \_\_\_\_\_

Address \_\_\_\_\_

City \_\_\_\_\_ State \_\_\_\_\_



H. GERNSBACK, President  
 S. GERNSBACK, Treasurer  
 J. M. HERZBERG, Vice-President  
 I. S. MANHEIMER, Secretary



JOHN F. RIDER,  
 Editor Service Dept.

R. D. WASHBURNE,  
 Technical Editor

HUGO GERNSBACK, Editor-in-Chief

C. P. MASON,  
 Associate Editor

VOLUME II  
 NUMBER 6

## Contents of This Issue

DECEMBER  
 1930

	PAGE		PAGE
<b>EDITORIAL:</b>		<b>TELEVISION:</b>	
Home Radio-Recording.....	By Hugo Gernsback 327	An Electrical Scanning System for Television	
<b>SERVICE MEN'S DEPARTMENT:</b>			By Philo T. Farnsworth 346
Why Radio Servicing Grows Daily More Complex	By John F. Rider 328	News of Television .....	349
Leaves from Service Men's Notebooks	By RADIO-CRAFT Readers 329	Actual Television Now Taught in School	By Harold C. Lewis 350
Operating Notes for Service Men..	By Bertram M. Freed 330	A New Synchronizer for Television..	By C. H. W. Nason 351
The Service Man's Open Forum.....	331	<b>SHORT-WAVE CRAFT:</b>	
<b>RADIO SERVICE DATA SHEETS:</b>		The "Superband" Converter for Short Waves	By Pierre J. Noizeux 352
No. 31—Howard "Model SG-A" .....	332	Selecting the Intermediate Frequency..	By L. W. Hatry 353
No. 32—All American-Mohawk "Model D" Lyric.....	333	With the Short-Wave Experimenters.....	353
Principles of Automatic Volume Control	By Wallace Salz 334	Short-Wave Notes .....	374
How to Make a Good Service Oscillator	By K. T. Vedder and E. C. Hughes, Jr. 336	<b>RADIO CONSTRUCTION AND THEORY:</b>	
Favorite Testing Equipment of Service Men .....	337	How to Build a Direct-Coupled Amplifier	By S. H. Burns 354
<b>NEW DEVELOPMENTS IN RADIO:</b>		Letters from Our Radio Craftsmen.....	355
Radio, the Most Exact Timekeeper.....	338	Remote Control and the Built-In Radio Set	By Joseph Attardo 356
Home Recording of Radio Programs and Speech.....	340	RADIO-CRAFT Kinks .....	357
New Antennas "Directional" at High Angle.....	342	The Hows and Whys of the Push-Pull Circuit	By Edgar Messing 358
New Radio Devices for Shop and Home.....	343	A New Element in Tube Design	By Henri Francois Dalpayrat 359
A "Police" Short-Wave Set for Automotive Use.....	344	RADIO-CRAFT's Information Bureau .....	360
Hints to Radio Manufacturers	By Radio Users and Service Men 345	Statement of Ownership, etc. ....	381
A Modified "Stenode Radiostat" for General Use.....	345		

## In Forthcoming Issues

**MORE ABOUT MIDGET SETS.** The small, or "mantel-piece," set has made a bit with the radio public. Its low cost and convenience of placement are what most buyers want. For this reason, the Service Man will be interested in the problems which it raises. Full information on the latest models will be forthcoming in the next issues of RADIO-CRAFT.

**PRINCIPLES AND CONSTRUCTION OF TONE CONTROLS.** There is a division of opinion among radio engineers as to whether the tone control is a step forward or a step backward; but it makes a hit with the public. Sopranos are no longer like the weather—something can be done about

them. For that reason, the Service Man and set builder are financially interested in tone controls which can be applied to any existing set. Several forms will be described.

**CONSTRUCTION AND THEORY.** Many of our readers, who are experimentally inclined, will find very attractive suggestions in: "Screen-Grid Tubes as Frequency-Changers," by R. Tabard, showing what is done in Europe; "A Vacuum-Tube Band-Selector" by Henri Francois Dalpayrat, describing a brand-new circuit; and "Dual-Crystal Rectification," by R. J. Robbins. And many other articles of practical value.

RADIO-CRAFT is published monthly, on the fifth of the month preceding that of date; its subscription price is \$2.50 per year. (In Canada and foreign countries, \$3.00 a year to cover additional postage.) Entered at the postoffice at Mt. Morris, Ill., as second-class matter under the act of March 3, 1879. Trademarks and copyrights by permission of Gernsback Publications, Inc., 98 Park Place, New York City.

Text and illustrations of this magazine are copyright and must not be reproduced without permission of the copyright owners. We are also agents for WONDER STORIES, AMAZING DETECTIVE TALES and WONDER STORIES QUARTERLY. Subscriptions to these magazines may be taken in combination with RADIO-CRAFT at reduced Club rates. Write for information.

Copyright 1930. GERNSBACK PUBLICATIONS, INC.

Published by  
**TECHNI-CRAFT PUBLISHING CORPORATION**

Publication Office: 404 No. Wesley Ave., Mount Morris, Illinois

Editorial and Advertising Offices  
 96-98 Park Place, New York City

Western Advertising Office  
 737 North Michigan Avenue, Chicago, Ill.

L. F. McCLURE, Western Advertising Representative

London Agent: Hachette & Cie.,  
 16-17 King William St., Charing Cross, W.C. 2

Paris Agent: Hachette & Cie.,  
 111 Rue Reaumur

Australian Agent: McGill's Agency,  
 179 Elizabeth St., Melbourne



# Get Into One Of These BIG PAY FIELDS

All practical work on real  
Electrical machinery

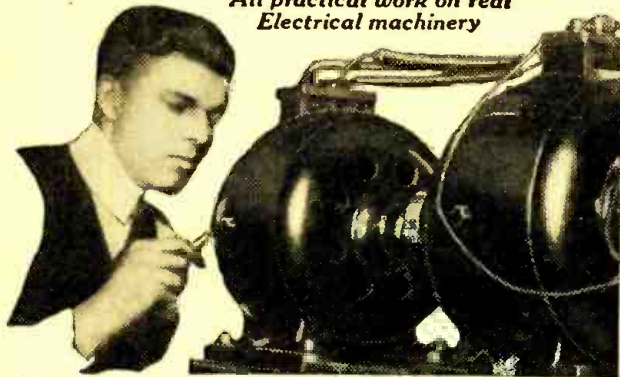

## Amazingly Easy Way to Get Into ELECTRICITY

Don't spend your life waiting for \$5 raises in a dull, hopeless job! Let me show you how to make up to \$60, \$70 and even \$200 a week, in Electricity—NOT by CORRESPONDENCE, but by an amazing way to teach that makes you a practical Expert in 90 days!

### Learn Without Books in 90 Days

No Books! No Lessons! You learn by doing actual electrical work right here in the Coyne Shops. You are trained on huge motors, generators, switchboards, transmitting stations, power plants, auto and airplane engines, etc. You don't need advanced education or previous experience. You qualify for real electrical work in 90 days!

### Earn While You Learn

Don't worry about a job! You get FREE life-time Employment Service. And don't let lack of money stop you. If you need part-time work to help pay living expenses, I'll help you get it. Coyne is 31 years old. Coyne training is tested. You can find out everything FREE. Just mail coupon below and I'll send you my BIG FREE ELECTRICAL BOOK, telling all about jobs—salaries, etc. This does not obligate you. Just send the coupon below!

### MAIL THIS COUPON FOR BIG FREE ELECTRICAL BOOK..

H. C. LEWIS, PRESIDENT  
COYNE ELECTRICAL SCHOOL, Dept. 90-81  
500 South Paulina Street, Chicago, Illinois

Gentlemen: Please send me your big Free Electrical Book with 151 illustrations. This does not obligate me.

Name .....

Address .....

City..... State.....

Student working on Television  
transmitter in  
Coyne Radio Shops



## Learn RADIO TELEVISION TALKING PICTURES

Every branch of Radio is calling for trained men! 6,000 Service Men needed at once. Big call for Wireless Operators, both at Sea and in the Air. Many jobs open in Broadcasting Stations. Talking Picture and Sound Experts in great demand. And now Television is on the way! Soon there'll be a demand for thousands of Trained Men in this one branch alone. Say "good-bye" to \$25 and \$35 a week—get into Radio, where thousands of jobs are open, paying \$60 a week and up.

### NOT BY CORRESPONDENCE

#### By Actual Work — in 8 Weeks

Come to Coyne and learn Radio in 8 weeks! NOT BY BOOKS OR CORRESPONDENCE, but by actual Radio work on actual Radio equipment—on scores of Radio receivers, huge Broadcasting equipment, the very latest Television transmitters, Code Practice apparatus, Talking Picture and Sound equipment, etc. No experience needed. You learn all branches of Radio in 8 weeks.

#### Free Employment Service

After you graduate, I'll help you get the Radio Job you want—and if you need part-time work while at school, I'll help you get that, too. Coyne has been training men since 1899. Let Coyne train you for a Big Pay Radio Job! Mail coupon below for a copy of my BIG FREE RADIO BOOK, telling all about Radio, Television, Talking Pictures, Wireless, etc. This costs you nothing. Just mail coupon below.

### MAIL THIS COUPON FOR BIG FREE RADIO AND TELEVISION BOOK

H. C. LEWIS, PRESIDENT  
RADIO DIVISION, COYNE ELECTRICAL SCHOOL  
500 S. Paulina St., Dept. 90-8H, Chicago, Ill.

Gentlemen: Send me your Big Free Radio Book and all details of your Special Introductory Offer. This does not obligate me in any way.

Name .....

Address .....

City..... State.....



# Announcing ~

# RADIO

## Service Man's HANDYBOOK

### WITH ADDENDA DATA SHEETS

**T**HIS new book contains a tremendous amount of the most important data of every kind — several hundred illustrations, wiring diagrams, charts, on every conceivable subject pertaining to radio sets, tubes, etc. The book is live "meat" from start to finish, and contains only practical information on which every radio man can cash in immediately.

Just to give you a few subjects contained in the book, we mention the following:

Prescriptions of a radio doctor  
 Modernizing old receivers  
 Servicing obsolete sets  
 Operating notes for Service Men  
 Service Men's data  
 Servicing automobile radio installations  
 Curing man-made static  
 Causes and cure of radio interference  
 Notes on repairing "B" power units  
 Constructional data on laboratory equipment

A portable radio testing laboratory  
 Servicing with the set analyzer  
 What and how the Service Man should sell  
 Helping the Service Man to make money  
 How to become a Service Man  
 Servicing broadcast receivers  
 All about vacuum tubes, and vacuum-tube data  
 Special radio Service Man's data  
 Dozens of radio service data sheets  
 And hundreds of other similar subjects

**\$2.00 PER COPY**

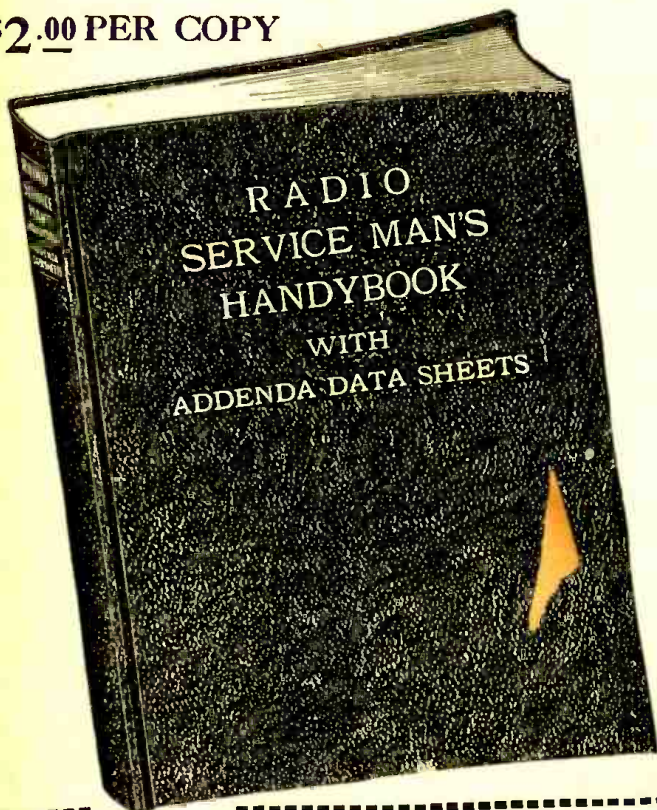

*The Foremost Radio Service Authorities Have Contributed to This Book*

- |                  |                  |                 |
|------------------|------------------|-----------------|
| C. W. PALMER     | GEO. C. MILLER   | H. WEILER       |
| LEON L. ADELMAN  | JULIUS G. ACEVES | J. E. DEINES    |
| SYLVAN HARRIS    | C. W. TECK       | F. R. BRISTOW   |
| BERTRAM M. FREED | PAUL L. WELKER   | and many others |

### A NEW DEPARTURE

**E**VERY Service Man, every radio man, every radio experimenter and every radio professional makes his own notes, draws his own circuits and writes down his own observations and his own data. For these reasons, the RADIO SERVICE MAN'S HANDYBOOK has been made in loose-leaf form. *There are supplied with this book 48 special ledger paper pages, square ruled on both sides so that you can take a leaf and place it wherever you wish, and write on it your own data.* If you wish, you can also cut out data from other publications and paste it on the sheet—placing it in its proper position in the loose-leaf book.

The total number of pages is 200 and the book contains such a wealth of radio material as you have never seen before between two covers. *Nothing like it has ever been produced.* The book is of the large size, 9 x 12 inches, and is in the same loose-leaf form as the OFFICIAL RADIO SERVICE MANUAL. It has a semi-flexible cover with gold stamping.

**MAIL COUPON TODAY**

GERNSBACK PUBLICATIONS, INC.,  
 96-98 Park Place, New York City, N. Y.

HC-12

Gentlemen:  
 As per your special offer, I enclose herewith remittance of \$2.00 (Canada and foreign \$2.25) which pays the entire amount on your new book entitled RADIO SERVICE MAN'S HANDYBOOK with Addenda Data Sheets, in loose-leaf form, as described in RADIO-CRAFT.

Name .....

Street .....

City and State .....



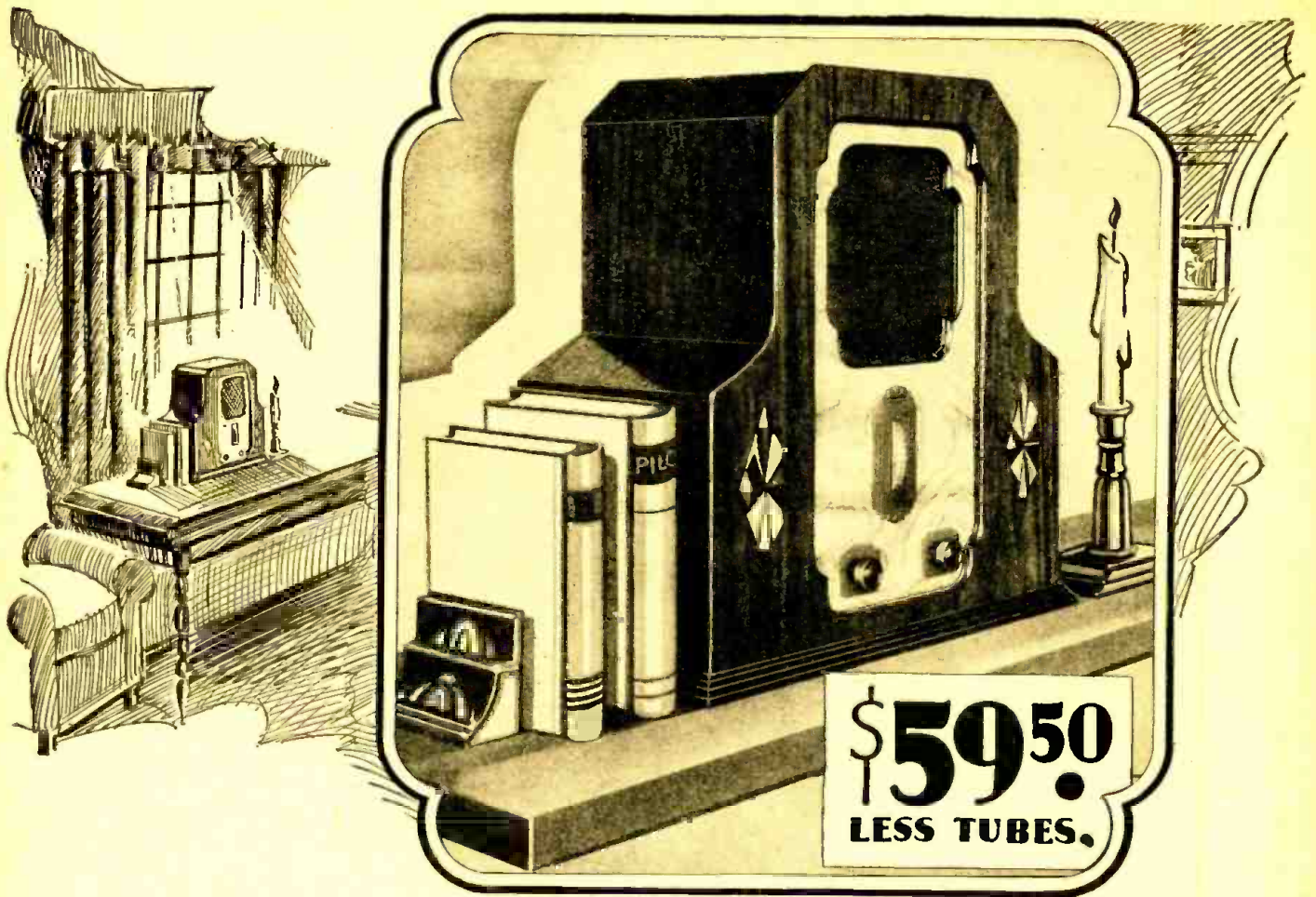

**Your Pilot Retailer  
Is Part of Pilot's Plant**

He is no mere middleman dealing through other middlemen. He is a representative of the factory chosen for his ability to cooperate with Pilot's laboratory engineers in seeing that you enjoy all the abundant satisfaction built into every Pilot product whether it be kit, set, tube, or accessory.

This compact A. C. Midget Receiver in its beautiful two-tone walnut cabinet gives radio performance of cansale quality. Its modest price is only possible because every part, including tubes, was designed by the same engineers, and made by the same skilled workers—all under one roof—that of the Pilot Radio Plant, the largest factory owned and operated by a radio manufacturer. It is the outstanding miniature receiver in selectivity and sensitivity because of two screen grid stages; in undistorted tone, because of Screen Grid Power Detection; in volume and depth of tone, because of 1-227 audio stage and 1-245 power audio stage. Full Shielding. Its special electro dynamic speaker of Pilot design, is the last touch necessary for complete superiority. Pilotron Tubes are furnished with every Pilot Midget because Pilot retailers know none are more reliable, and that unreliable tubes cause 80 per cent of their service troubles.

**PILOT RADIO & TUBE CORP.**

Chicago Office:  
234 S. Wells Street

LAWRENCE, MASS.

San Francisco Office:  
1278 Mission Street

**PILOT**  
**MIDGET**

L I C E N S E D      U N D E R      R C A      P A T E N T S



# "Official" RADIO SERVICE MANUAL

and Complete Directory of all Commercial Wiring Diagrams

IN LOOSE-LEAF FLEXIBLE, LEATHERETTE BINDER

OVER 1,000 ILLUSTRATIONS, DIAGRAMS, Etc.

352 PAGES 9" x 12"

Weight 2 1/2 lbs.

HUGO GERNSBACK, Editor  
CLYDE FITCH, Managing Editor

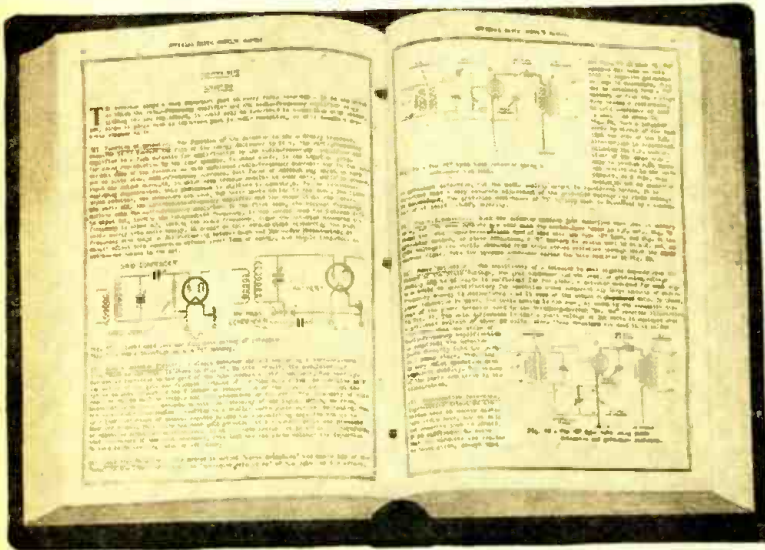

Prepared Especially for the Radio Service Man!

NEVER in the history of radio has there ever been published a service manual, so complete, as this new OFFICIAL RADIO SERVICE MANUAL. It is a veritable encyclopedia of service information—worth several times its price. It is invaluable not only for the Service Man, but for everyone interested in radio.

THE BIGGEST RADIO VALUE IN AMERICA TODAY!

\$3.50 A COPY

There has been collected for this manual wiring diagrams and data of nearly every commercial set, of which there is any available record, manufactured since 1927, and many earlier ones.

The OFFICIAL RADIO SERVICE MANUAL is made in loose-leaf form in a handsome, durable, flexible leatherette binder and contains 352 pages of the large size, 9 x 12.

Additional service data for new receivers, as they appear on the market, will be published and supplied at a trifling cost so that the MANUAL may be kept up-to-date at all times. But that is not all.



MAIL COUPON TODAY—

## SERVICE INFORMATION

The OFFICIAL RADIO SERVICE MANUAL contains also a most comprehensive instruction course for the radio Service Man, giving practical information from every angle on how to service the set. Here are only a small number of the articles mentioned:

- Amplifiers (Audio and Radio)
- Automotive Radio
- Antennas
- Condensers
- Detectors
- Eliminators
- Meters
- Power Supply Systems
- Radio Phonograph Equipment
- Resistors
- Short-Wave Sets
- Speakers
- Tubes

You simply cannot realize what a tremendous work this is until you have held a copy in your hands and have gone through its 352 pages. Over 1,000 illustrations, diagrams, etc.

### WHAT THEY SAY

NOTHING CAN COMPARE WITH IT. I have received my copy of the OFFICIAL RADIO SERVICE MANUAL. I expected it would be good for I think you know as much as any of them what the average radio man wants but I'll wager you very many expected to receive a book comparable to this one. I think you deserve a lot of credit for being the first to put out a real service manual that the amateur or professional can make good everyday use of. It's a good practical book and one that every service man will be proud of.—E. D. HANA, Haslett, Mich.

BEST BOOK IN THE FIELD. I received your book OFFICIAL RADIO SERVICE MANUAL and I find it is as yet the best book I have found in this field of radio. You are well justified in that this is the peer of service manuals. I wish you all the success possible in the publishing of future books on radio which are sure of great necessity.—WILLIAM H. BROWN, Brown Radio Service, 1010 Buckingham Street, Toledo, Ohio.

WORTH A GREAT DEAL MORE. Received your copy of OFFICIAL RADIO SERVICE MANUAL and am greatly pleased with same. It is worth a great deal more than it costs.—HAROLD AIGUIER, 41 Rutland Ave., Arlington, N. J.

"SHE IS A BIRD". Just to let you know we received my MANUAL, this A.M. and "OH BOY!!" "She is sure a BIRD!" You sure did strut your stuff, AND HOW!!—V. H. HERNDON, Herndon's Radio Shop, Odon, Indiana.

EXTREMELY PLEASED. I acknowledge receipt of the OFFICIAL RADIO SERVICE MANUAL and I am extremely pleased with it.—EDW. JOHN SMITH, 337 E. 26th St., Erie, Penna.

A VERITABLE GOLD MINE. I received the OFFICIAL RADIO SERVICE MANUAL. I am well pleased. It is a veritable gold mine for the Service Man.—EUGENE BINFORD, Arkansas City, Kansas.

MAGNIFIQUE. Received my copy of the OFFICIAL RADIO SERVICE MANUAL this A.M. "She is what you call him? Magnifique! Exquisite!" A timely aid for the troubled sets. Thanks.—E. BOICE, 1118 W. Dauphin, Philadelphia, Pa.

FINEST THING. Just received the RADIO MANUAL. It sure is the finest thing I have seen.—E. J. SCHWARTZ, 465 Eddy Road, Cleveland, Ohio.

IT ASTOUNDED THEM. Everywhere I have exhibited the MANUAL, it has taken the boys by surprise and its completeness has astounded them. For instance, Saturday morning last I had occasion to run into the service plant of the Mackenzie Radio Corp., New York District Distributors for Zenith Radio, in connection with replacement units, and when I showed the Service Manager, Mr. Wandelt, the MANUAL, he was agreeably surprised and called the men to see the work. Delighted by yours, and always a booster for Gernsback Publications, of which I read practically all, and study them.—IRA C. HALDERMAN, 44 Leroy Place, Ridgewood, N. J.

GERNSBACK PUBLICATIONS, Inc., RC-12  
96-98 Park Place, New York, N. Y.

As per your special offer, I enclose herewith \$3.50 for which you are to send me postpaid, one copy of the OFFICIAL RADIO SERVICE MANUAL.

Name .....  
Address .....  
City ..... State .....



**"Takes the Resistance Out of Radio"**

Editorial Offices, 96-98 Park Place, New York, N. Y.

## Home Radio-Recording

By Hugo Gernsback

**H**OME-RECORDING is not a new idea by any means. Years ago (to be exact, in the September, 1915, issue of one of the writer's former magazines—*The Electrical Experimenter*), I published an illustrated article showing how a Jersey inventor had recorded code messages on a wax phonograph cylinder.

This was the beginning; and, during the intervening 15 years, much work has been done in recording, not only on cylinders but also on discs, and even films, the usual radio programmes. In the past, most of this work was of a commercial or professional nature, but, from now on, there is to be added to radio reception, the practice of home-recording.

This in time may assume formidable proportions. Already a number of firms are putting out kits which can be attached to any existing phonograph and radio. The price of the kit is kept within reason; and the writer would not be surprised to see such kits finally sold even below \$10.00, if the public takes home-recording to its heart, and the use of it becomes universal.

There is a certain fascination in recording your own voice; as no one knows in advance what his own voice sounds like. Most people are exceedingly surprised when they first hear the quality of their own speech, as transcribed by a phonograph record. There are, of course, many excellent recommendations for home-recording: first, the novelty; second, as a means of entertainment for parties, etc. Then we have the more serious use, by parents who wish to preserve the voices of their children at different stages of their growth; such records can be kept for years without deterioration. The converse is true, where the children wish to perpetuate the voices of their parents and grandparents, as well as friends; to recall them for years to come and to hand them down to coming generations. A record of this type, like a photograph, may be kept and cherished for many years.

In addition to this, it is now possible to record anything that comes in over the air by radio; such as an address by the president of the United States, or any other dignitary, arias by great singers, and any special programs we wish to record. Very often excellent artists are on the air when favorable reception permits making a good record of their voices or instruments;

and the owner will always feel a little prouder to let his friends hear a self-recorded transcription rather than the commercial article.

These are only a few of the many apparent uses of home-recording; but of course there are many more. These are not only strictly of a home and non-commercial nature, but others may be applied to purely commercial work. A number of such opportunities will occur to enterprising radio workers.

While the art of home-recording is still new, and may be looked upon as only a novelty by many, yet the wide-awake radio dealer or independent Service Man will appreciate immediately that a new source of income is being opened to him. Everyone who owns a radio and a phonograph is a prospect for a home-recorder and, right now, it will be a good sales point to present to a customer because, in many cases, he will be the first one in his locality to have one when the sale is made. A single demonstration usually should be sufficient to sell the average individual, particularly when he realizes that it is only the first cost that counts; since the record blanks are exceedingly cheap and the upkeep for the home-recording instruments is practically nil.

Of course, the Service Man or radiotrician will first have to familiarize himself with the home-recording instrument, and become posted in the mechanical features; so that, when a demonstration is given, it will be perfect and will show immediate results. Most of the home-recording instruments on the market now are simplicity itself and it is rather easy to make records; so that even an intelligent child can become proficient in the recording. Inasmuch as home-recording is apt to develop into a big adjunct to radio, thereby producing additional income, it will be wise to get behind the movement in earnest and shout it from the housetops, rather than let nature take its own course.

In the past, many good radio ideas have been developed, but, unfortunately, individuals in the radio trade were always the first to knock the idea; with the final result that those who pooh-poohed the idea were the first to get out of the radio business.

Let us hope that the home-recording idea will take root, for it is meritorious and can be made a big adjunct to radio.



# Service Men's Department

*This department is about the Service Man, for the Service Man, and largely by the Service Man. Its contributors are practical men, and we invite every Service Man in the country to tell about his own experiences of all kinds.*

Edited by JOHN F. RIDER

## WHY RADIO SERVICING GROWS DAILY MORE COMPLEX

By John F. Rider

ONE need not be a close observer to note that the panorama of set design has undergone a great change during the past three or four years—as a matter of fact, even during the last two years. There was a time when any man conversant with the technical side of radio could design a radio receiver. There was no need for an extensive grounding in engineering; because most of the work was of the cut-and-try nature and the requirements were very few. Service, at that time, necessitated only ordinary bell-ringing-circuit experience.

Not so in this day of thorough design. Just as the requirements for set designers or engineers have increased, so have the complexities presented to Service Men kept pace with the improved design. There is no longer room for the cut-and-try engineer, and there is no room for the "Cut-and-Try" Service Man.

Each new model of a radio receiver introduces some innovation or some change in design which makes the receiver more complex, so far as technical detail is concerned. Suppose we analyse some of the modern receivers, and compare them with the systems of yesteryear.

The introduction of the band-pass filter became a necessity as the number of stations upon the air increased, and as the demand for better quality of reproduction was voiced with sufficient loudness. Essentially, the band-pass filter is somewhat like the ordinary tuned radio-frequency transformer; both allow the passage of a certain band of frequencies. However, the design and operation of the radio frequency band-pass filter is much more complex than that of the ordinary tuned radio-frequency transformer; the number of circuits involved is greater, and the number of units involved is also greater. To be in a position to effect some corrective remedy, in the event of trouble, the Service Man must be familiar with the design and operation of such circuits.

To add to the complexity of the circuit there is the present use of systems whereby the original fault of the conventional radio-frequency band-pass filter is corrected. The first receivers to employ band-pass filters were afflicted with trouble of a peculiar type; the filter system performed well over a certain frequency band (perfectly, to be exact, upon only the carrier frequency.) For frequencies below and above this figure, the width of the band passed was either greater or smaller than the required 10 kilocycles, depending upon the form of coupling used between the parts of the filter.

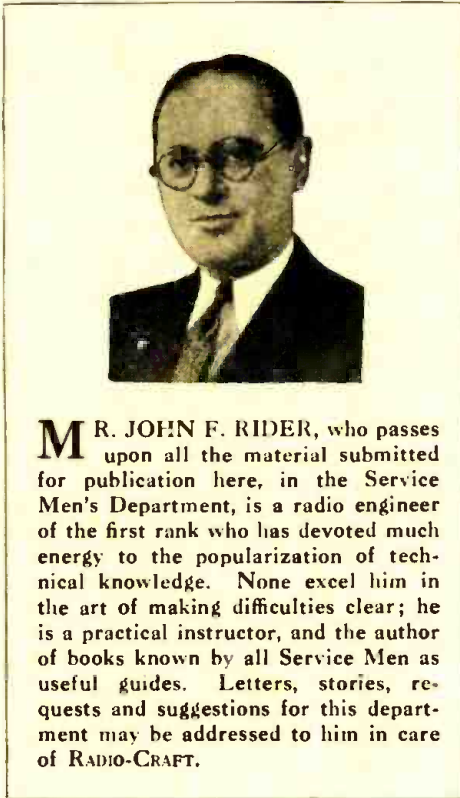

**M**R. JOHN F. RIDER, who passes upon all the material submitted for publication here, in the Service Men's Department, is a radio engineer of the first rank who has devoted much energy to the popularization of technical knowledge. None excel him in the art of making difficulties clear; he is a practical instructor, and the author of books known by all Service Men as useful guides. Letters, stories, requests and suggestions for this department may be addressed to him in care of RADIO-CRAFT.

The modern receiver is no longer troubled by such difficulties. Engineers have now combined the properties of inductive and capacitive coupling, in such manner as to secure a constant width of band over the entire broadcast range. Whereas a man could once become familiar with either the capacity- or the inductively-coupled type of radio-frequency band-pass filter, and hope to pass on that score, he must now be familiar with, not only both of these coupling arrangements, but also the combined effects. Furthermore, engineers have developed more complex forms of capacity coupling whereby uniform width of band-pass is secured without combining two forms of coupling. The comprehension of such arrangements is not difficult, if one sets himself to the task; but, if practical experience is to be the sole teacher, much water will pass beneath the bridge before even the functions of the various elements are understood.

To add to the complications, which make study even more necessary, some of the parts employed in such systems are necessary in order to accomplish an end which is seldom discussed in the ordinary radio text book. Theory will consider the requirements and the characteristics of coupled circuits, but does not include the additions necessary in order to provide the correct degree of regeneration upon the high or low frequencies. To arrive at the final answer,

one must combine the coupled circuit with the additional elements used, and ascertain the action of the whole by considering the action of the individual parts. Thus, for example, one must know the action of a resistance in a radio-frequency tuning system, and also know the action of the coupled circuit, in order to arrive at the combinations used today. This knowledge must be gained by study.

It is not a far-fetched statement that the Service Man of the future will have to be an engineer (at least a practical engineer) if he is to understand the operations of the design engineer. Take, as an example, the use of the electric motor in connection with the modern radio receiver. There was a time, not long past, when there was no thought of any relationship between the radio receiver and a motor. But remote tuning control is gradually becoming a reality and, to understand and service such systems, the Service Man will have to be thoroughly familiar with the principles of fractional-horsepower motors. As far as the size is concerned, it is of no consequence; the knowledge required will be that related to the principles of motors.

As a matter of fact, the use of such a motor is not limited solely to remote tuning-control system. One manufacturer has introduced the clock form of automatic tuning; in other words, one can set the clock to change the tuning of the receiver in accordance with the hour, thereby automatically tuning to whatever program is desired at that time. Furthermore, home recording of the voice or of the received program is another innovation which involves the use of a motor. Who will service such motors? Will it be out of the Service Man's field, and become that of the electrician? Is competition of this nature in the offing? The logical one to service each and every part of the radio installation is the radio Service Man.

What about the home talkies? The system is built around the audio amplifier in the receiver. In the event of trouble, the radio Service Man will be called upon to repair such systems. As a matter of fact, it is not fanciful to state that the future radio receiver will be a combination of a receiving system, a television system and a home "talking movie." If this is to be within the scope of the Service Man, and the systems made successful, the Service Man must become familiar with optics, lenses, photoelectric cells, neon tubes, microphones, record-cutting devices, etc.

But why speak about a year hence? Consider the present. The home-recording system is a feature of some of the new receivers introduced at the show in New York. Hence the microphone and the motor and

(Continued on page 365)



# Leaves from Service Men's Note Books

*The "Meat" of what our professionals have learned by their own practical experiences of many years*

By RADIO-CRAFT READERS

## NOTES ON VICTOR MODELS

By R. Hedley Childerhose

**I**N Victor "R32" and "R.E. 45" receivers, hum is quite often caused by the "Radio-Phono" transfer switch. Tighten the two screws that hold the contact springs and insulation together.

A soft centre in the cone of the dynamic speaker causes a snapping noise on loud signals. It is generally necessary to replace the cone; although in some cases a round piece of adhesive tape, stuck over the weak center, overcomes the trouble.

A good method to center the cone is: remove the speaker from the baffle board, leaving the cable plugged into the power pack, set turned on. Loosen the screw in the center of cone. Remove first R.F. 26 tube to prevent signal coming through; then turn "Hum Control," on rear of power pack, to extreme left. Tighten center screw, and test by running your finger lightly around cone, near the rim. A uniform buzz should be heard on all sides. If tone varies, loosen screw, press slightly on one side, and retighten. Readjust hum control.

The leads to the record volume-control on "R.E. 45's" are held by screws, which often loosen, causing intermittent record reproduction. The loose lugs sometimes short, killing the phonograph section, or shorting it to full volume.

Ball or cage types of aeriols are usually noisy on these sets, and it is best to change to single-wire aeriols where interference is bad, or signals are weak.

## SERVICING CROSLEY MODELS

By V. G. Whipple

**A**NY Service Man who has had occasion to service a number of Crosley screen-grid sets knows the inconvenience of partially disassembling the chassis in order to clean the antenna switch. This part, on the earlier models, was certain to give trouble periodically. However by mixing two teaspoons of Nujol with a small bottle of Vaseline, and placing this on all parts of the switch, the trouble will be remedied and will not return for a long time. If you will use a pipe cleaner, one end of which is liberally coated with this mixture, and insert it through one of the small holes in the bottom of the chassis beneath this antenna switch, you will find that the switch may be lubricated without even removing the chassis from the cabinet. Use a flashlight in order to see properly.

Crosleys, particularly the "Showbox" models, give some difficulty with poor connections to the rotor of the condenser gang. This may be remedied by loosening the set screws in the thick washer at the rear of the condenser gang, removing this and the other washers, and cleaning them thoroughly. Sandpaper them until bright and lubricate them with the Nujol-Vaseline composition.

If the socket prongs on these same sets

become tarnished or corroded, giving poor contact with the tube prongs, this is easily cured by putting the same composition on the tube prongs; then insert the tube into the socket and work it around a little to spread this material.

In the case of late Crosley models, as well as sets of some other makes using 45 power tubes, a peculiar sound similar to motor-boating is frequently caused by gassy "45" tubes. Replace one or both of them and the trouble will stop.

Another peculiar thing I have found several times; the bolts holding down the base of the dynamic speaker, because of irregularities in the surface of the wood beneath the base, had drawn the speaker frame out of shape and caused the voice coil to rub. Slightly loosening one or two of the bolts allowed it to return to normal.

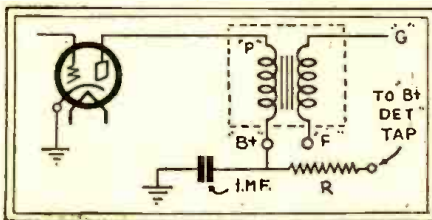

*The 1-mf. by-pass condenser shown above will often greatly improve the output of a set, particularly when its filtering action is aided by the use of R. An appropriate value for this resistor is 60,000 ohms.*

## ADDITIONAL BY-PASSING

By D. V. Chambers

**I**N almost any set operated electrically, a 1-mf. condenser, in the detector plate circuit between the "B" of transformer or coupling resistor and ground will greatly reduce hum, and also help to clear up tone and eliminate coupling with the R.F. stages.

In early Kolster battery sets, the grid resistor-condenser combination in R.F. grid circuits is a frequent cause of weak or no reception.

## A ROOF FOR COUNTERPOISE

By C. H. Lembeck

**A**N unusual solution to the usual service problem—interference—was cured in the following manner. The location was the third floor of the Post Publishing Co. in the center of the business district of Appleton, Wis., and speech was absolutely unintelligible on the receiver, a Kennedy. A lead of Belden shielded wire was first used, the shield being grounded on the tin roof. The set had a separate ground on a rod; and, when the ground wire was accidentally jerked loose, I noticed the usual increase in signal, while the noise level remained the same.

This suggested the "ham's" old standby—the counterpoise. It was simple to use the tin roof for this purpose, as it was ungrounded; and the outside braid was con-

nected to it. I ran a wire from the end of the braid to the ground post of the set—and the salesman promised to persuade the boss to get me a new service car, for saving the sale. If the window hadn't been open, we would have sworn there wasn't a motor going within ten miles, though all the presses were running downstairs.

This is not a universal solution, however; as most tin roofs are grounded. Nevertheless, the capacitive effect between the braid and the enclosed lead-in decreased outside interference surprisingly.

## EFFECT OF TEST PRODS

By Lloyd R. Brown

**R**ECEPTION in one Atwater Kent "Model 60C" (second type), which the writer was called upon to service, was obtained only by placing a finger on the grid cap of the second R.F. screen-grid tube, and holding it there. Believing that a short lurked within this stage, I took the chassis from the cabinet and tested for continuity. Everything then seemed O.K.; but I found that, by placing and holding the finger on one terminal of the plate choke in the second stage, reception was obtained just as by touching the grid cap.

Close examination of the choke showed that the winding was broken beneath the solder of this terminal; but, when the choke was tested for a short, it registered O.K. because the slight pressure from the prods was sufficient to restore the broken contact and allow current to flow. After the choke was repaired, the set worked perfectly.

## SHUNTING AN AMMETER

By John J. Nothelfer

**T**HE range of any milliammeter may be conveniently increased by using old resistance wire, taken from a discarded rheostat, and wound on a nail to obtain a coiled wire. One end of this is connected to one of the terminals of the meter.

A load should be put on the meter that  
(Continued on page 365)

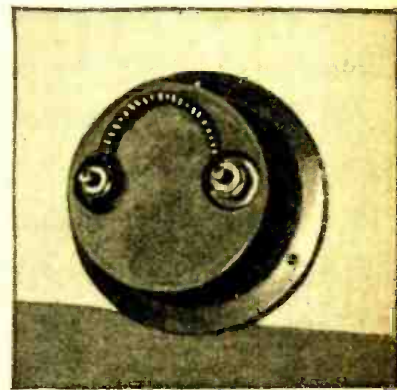

*Mr. Nothelfer's way of applying a shunt to alter a meter's scale is simplicity itself.*



# Operating Notes for Service Men

*As a rule a commercial set, however well built, must have some point weaker than the rest at which trouble may be first experienced. Here are a few suggestions on where to look for trouble in certain commercial models.*

By BERTRAM M. FREED

**R**ECENT cases of fading encountered in the Amrad "Nocturne" ("Type 7100") were finally traced to the fuse block, which is fastened to the side of the cabinet; this has two fuses, one in either side of the line. If the clips holding the fuses become corroded and lose their tension, the resulting poor contact will cause fading; which will be evidenced by flickering or dimming of the pilot bulb. This, however, is difficult to detect; because the dial is black with a white scale, and a slight change is not at once apparent. It is a good policy to clean all fuse contacts and bend up the clips, thus possibly preventing a repeat call.

The other cause of fading in this model (not counting a poor '27 as the detector, or a loose element in one of the '26s) is found in the audio transformer leads, which pass from the unit through holes in the chassis to the terminals under the chassis. The openings are just large enough for the leads; strain and vibration may cause a short to the chassis, when the metal has cut through the insulation of the leads. Pulling on the latter, while the set is in operation, will quickly show whether fading is due to this cause. These transformers, which are mounted in bronze housings, may sometimes be repaired, in case of a short between the windings, by heating them. The wax compound will flow and introduce an insulation, between the shorted primary lead and the case.

## Connections to be Watched

When replacing volume controls in the Victor "32," "45," etc., care should be taken to resolder the proper wires to the proper variable resistor. This chassis incorporates

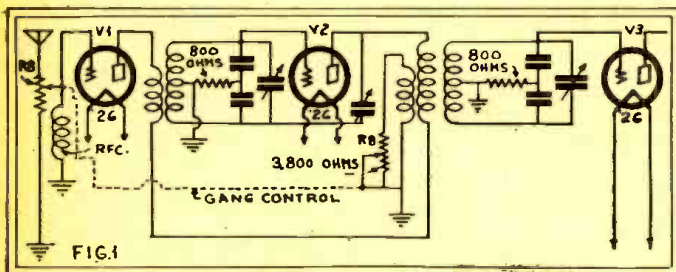

a dual volume control; one resistor is an aerial potentiometer, the other is across an R.F. absorption-circuit winding (Fig. 1). The arm of the latter resistor is fastened to the metal construction of the unit and, consequently, is grounded when mounted to the metal chassis; the other, coupled to the first by a strip of bakelite insulation, should be connected to the grid lead of the first R.F. tube.

The writer has previously mentioned causes of fading in the Colonial "32AC"; in this model, directly behind the push-pull input transformer, there is a triple-lug flat

bypass condenser marked "4407-P" which will cause fading if it open-circuits. Tapping lightly with the back of a screwdriver, while the set is in operation, will quickly show if there is a defect in this condenser.

In this receiver, also, several fixed carbon resistors are used in different parts of the R.F. circuit. Such a component is covered at one end with black spaghetti, with a lead several inches long; under the spaghetti is a connection to the pigtail of the resistor. If this connection is not properly soldered, intermittent reception and fading may be caused.

On the new Colonial "33," complaints of lack of volume have been caused by the slipping of the braided copper belt on the drum carried by the control shaft; the result was that the ticklers were not properly varied. This is easily remedied.

An elusive hum on Philco phonograph combinations, not occasioned by a bad tube, has been removed by grounding the framework of the phonograph motor to the set chassis.

## Shielding the '27 Detector

In the latest Atwater Kent screen-grid model, a metal shield resembling those used for the screen-grid tubes is slipped over the '27 detector, and grounded to the chassis through the screen-grid cap lead. This is furnished with the set (packed with the ground clamp) and should not be omitted; as it eliminates hum and microphonic conditions.

Many Service Men have been regularly replacing the '99 tube in the Peerless Kylectron; some use a '20, which lasts longer. The writer has found, however, that an '01A does the trick and removes the danger

*The connections of the volume control in the Victor "32" and similar models; two potentiometers are built into one instrument, but their arms are not electrically connected. The arm of one is grounded, the other is at an R.F. voltage above ground. Replacements should be made carefully.*

of burnout. This tube acts only as a supplemental rectifier, to furnish additional polarizing voltage for the electrostatic speaker.

A recent meeting of a group of Service Men with representatives of the Fada factory was featured by a discussion of the new models. In reply to the objections of the Service Men that they had been put to undue labor in replacing a pilot or flash lamp, by having to remove several bolts and knobs, the engineer pointed out that it is necessary only to remove the escutcheon plate, which is held by a screw, and is easily pried off as soon as that is taken out. When

the escutcheon is replaced, it is necessary to note that it lines up, so that the key may be inserted into the "Flashograph" mechanism. However, if the replacement bulb still fails to function properly when the dial is turned, it will be necessary to take out the chassis to get at the flasher mechanism.

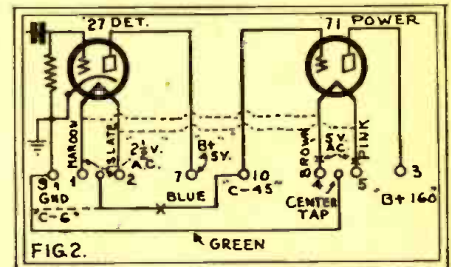

FIG. 2. Replacement of a '71A with a '45 in the Kolster "Model 65" gives better output.

In the Kolster "65," all cases of fading have been traced to the filament rheostat; corrosion on the contact arm and resistance strip causes a variation in voltage on the '26 tubes. Cleaning with steel wool and bending down the slider to increase the contact pressure will remedy this trouble.

## Rearranging a Power Stage

On this same model, if slightly greater output is desired, it will sometimes be found advantageous to replace the '71A with a '45. No rewiring of the chassis is required; the center tap of the '27 filament winding, which is grounded, should be disconnected and led to the No. 10 tap (Fig. 2). The filament leads to the power stage are disconnected from taps 4 and 5 and fastened to Nos. 1 and 2; this will place the needed 2½ volts on the '45. All sets that have been changed over in this way have given clearer output.

The only connections from the Sparton pre-selector to the R.F. amplifier are to the chassis (ground) and through a pin which fits into an opening in the amplifier to make connection with the grid of the first tube. If the amplifier is removed for any purpose (say to replace the pilot light) be certain that this pin is seated properly in the spring eyelet of the amplifier when the latter is replaced.

## Electrolytic Condenser Contacts

In the Sparton "930" and similar models, noisy and fading reception has been caused by poor contact between the can (negative electrode) of the electrolytic condenser and the chassis. This condenser is seated in a circular opening in the chassis, to which it has no other electrical connection. If the copper corrodes, it must be cleaned to restore proper contact. Sometimes it is necessary to bend up the metal flange of the opening, which is punched into the chassis, to give the needed pressure.

(Continued on page 366)



# The Service Man's Open Forum

*His Opinions on Conditions and Practices in the Radio Business*

## SMALL SALES AND QUICK RETURNS

*Editor, RADIO-CRAFT:*

I think Service Men generally would appreciate the diagrams and notes of radios put out by the big mail order concerns; these are widely distributed, and those I have come in contact with are all standard factory-built sets, built under R. C. A. patents. The Sears-Roebuck "Silver-tone" sets are nicely put up and, if one had a diagram to follow, it would help considerably. I recently had a case of the primary winding in the power transformer being open, and I could have used a diagram to considerable advantage. It was easily repaired, once located and the transformer removed; but it was some job tracing out the connections with nothing to guide me.

I was called in this morning to see a refractory Crosley, that proved to have only a broken heater in the '27 detector. When first turned on, it gave full volume, then gradually died down and as gradually came on again. When the porcelain surrounding the filament was cool, it held it together, and current passed. When the porcelain expanded, it caused the filament to spread, with consequent fading; and, when the porcelain cooled, contact was restored, and so on. I knew as soon as I heard it that trouble was in the detector. I put in a new tube, and everything was O.K.

The tube cost me \$1.27, and I charged the set owner \$3.50 for a few minutes' work—and she was tickled pink. I understood this when she told me that she had called a man from one of our largest service companies and, after making several highly important tests, he had told her that the power plant was shot and he would have to take it to the shop. He told her that it would cost between \$35 and \$40 to repair it, and charged her \$2.00 for the information. Fortunately, she was not sufficiently impressed by his wisdom, and didn't let it go. After she recited all this to me, I thought perhaps I had better scrutinize the set a bit closer; but a thorough test revealed nothing wrong, and it's going like a house afire.

I have already received two more calls, directly traceable to this customer. So my old theory, "Good work is the best advertisement" has again proved itself.

THOS. C. GENTRY,

324 West 65th St., Los Angeles, Calif.

## PROTECTION AGAINST LIGHTNING

*Editor, RADIO-CRAFT:*

I noted an article in a recent issue of RADIO-CRAFT regarding lightning and its effect on aerials, and I would like to say a few words about my experience with it. I have never found a lightning arrestor that could be depended on in diverting lightning and preventing damage to radio sets or radio apparatus. I have never found a S.P.D.T. switch that has failed to save the set and accessories, when used.

For instance, suppose you install a lightning arrestor between aerial and ground; and then leave the set's light cord attached to the lamp socket. Well, when you think

everything is all right after a severe storm, you discover the lightning had done damage to the receiver and the thing is dead or smokes. Fact is the lightning or excess voltage over the light line has done the damage; it did not come over the aerial at all.

The only safe method I know of in protecting A.C. sets is to use the throw switch, absolutely disconnecting the aerial and ground both from the receiver by using a D.P.D.T. switch instead of S.P.D.T. Then use a safety plug between the light socket and the receiver plug which protects the set from excess voltage; such a device is available on the market in several makes. I have replaced these after high-voltage and lightning strokes, so called. If a Service Man will protect a set by above methods, all damage by storms, etc. will be reduced to the zero point.

Any kind of a splice in the aerial and ground should be avoided. I do not recommend even a soldered connection, except to ground rod. Even then it should be washed with alcohol, wrapped with heavy tinfoil and again with heavy insulating tape; and the rod driven under the ground out of sight with lead covered up to point of entrance to window. There is too much back firing to depend on an arrestor. Even with only a ground wire attached, a set can be damaged; as a jolt will shoot up through the ground and into the set. There is no excuse for damage to receivers when switches and safety socket plugs can be had at so little cost.

It took me some time to find this out, but I know what I am talking about from the service that was required by the old method. I never have any trouble now, so I pass it on. The fellow that knows, or thinks, he knows the old method is all right, will wake up some time with his own set blown. Lightning and electricity work funny capers some times, and the safe way is to break their path.

ROY C. HYDE,  
Rowan, Iowa.

## GETTING TOGETHER ON SERVICING

*Editor, RADIO-CRAFT:*

There are two sides to the question—dealer service vs. independent service: and to illustrate this, I may tell what has been done here. At a meeting of the dealers in this town, the matter of service was gone over; and it was agreed that none of them had work enough to hire a Service Man of his own; so I proposed to undertake the service work, and it has worked out fairly well as follows:

The usual charge for service work here is now \$1.50 per hour; and I undertook to do their work at \$1.00 per hour, giving them an opportunity to make a profit on it. At this rate, they were to bring the work to my shop, and call for it when finished. On outside calls, the rate was the same, plus the time spent in servicing the set; provided it was one of their customers who called and the job was referred to me.

When a set must be brought to the shop, on a job of this kind, the dealer is notified when the work is completed, and of the charges. I then deliver the set to the customer, collect the full charge, and credit the dealer for the amount due him, which is to be applied on the next job he brings in. Parts required for the service of any set are supplied by the dealer who sold the set; for these he charges full retail price, and we collect the labor charge. If the set is brought in by the dealer, and we furnish the repair parts out of our own stock, we charge for them at the retail price, and he makes his profit on the labor allowance. If new tubes or other accessories are required for a call that is referred to us, we put them in and charge the regular price. We have not yet been faced with the problem of service when selling new sets; but will probably find a way out.

At every opportunity, I talk with the owner of a radio set and try to bring the conversation around to service—the kind they get and would like to get. This gives me an insight into how Service Men work in other towns; and I try to profit by what is told me. This brings me to the question of cleanness.

Many set owners have said to me: "I hate to have that Service Man in the house; I am afraid he will leave grease spots around." There is no excuse for a Service Man's wearing dirty clothes; as servicing is not a dirty job. I do not say that we should dress to the peak of perfection; but at least our clothes, hands, etc., can be clean.

The same principle applies to tools; how many people say "He lays his tools anywhere and I don't like it." That is why a yard of cloth is always carried in my kit, to place my tools on. Or, again, they say: "His screw driver slipped and he put a long scratch on my front panel." These scratches can be covered over with a little stain, so that they do not show; but the best rule of all is to go slow on a front panel.

Then too, they say: "he promised to come at once, but did not show up for a week." So, if you cannot do the work in a reasonable time, say so and don't let it drag. To sum up, be clean, polite and careful.

An unusual case of trouble was found, some time ago, in an Atwater Kent "55," which intermittently made a noise as if it was warming up again. I found that one of the '45s would light for a while, and then go out again.

In a new Silver receiver, oscillation which could not be stopped by exchanging tubes was corrected by changing the dial light leads to the first audio filament circuit instead of the detector. This removed undesirable coupling.

When the volume drops in a set, look for loose connections to the cathode resistors; and, in cheaper sets, when by-pass condensers blow, check the resistors also, for they are apt to go too.

F. C. ROCKHILL,  
St. Regis Falls, N. Y.



### HOWARD "MODEL SG-A" SCREEN-GRID RECEIVER

This radio set is a product of Howard Radio Co., South Haven, Mich. A novelty in its design is the type of the tuning scale, which is a white strip, graduated in kilocycles, arranged to slide from side to side.

Following are the parts values used in this receiver: Tuning condensers C, .00036-mf.; C1, 0.25-mf.; C2, C3, C5, 0.9-mf. (in individual shield cans); C4, 0.5-mf.; C6, C7, .001-mf.; C8, C9, C10, each 8 mf. (Mershon electrolytic triple unit).

Volume in this receiver is controlled by the tandem unit R1-R2. The resistance of R1 is 20,000 ohms; R2, of the "tapered" type, has a resistance of 10,000 ohms maximum (two-thirds turned, about 2,500 ohms; and one-third reading, about 10 to 25 ohms); R3, 300 ohms; R4, R6, 10 ohms; R5, 15,000 ohms; R7, 900 ohms; R8, 1,600 ohms; R9, 2,300 ohms. The reproducer's field coil has a resistance of 2,400 ohms; and Ch. 2 is a 200-ohm unit rated at 20 henries.

The primary of L1 has a resistance of 9.5 ohms; while the primaries of L2, L3, L4 have a considerably higher resistance—245 ohms. The resistance of the primary of the input transformer T1 is 1,200 ohms; of the secondary, total, 10,000 ohms. The primary of T2 has a resistance of 400 ohms.

Operating current supply values for this set follow (tube out of socket): Filament potentials, V1, V2, V3, 2.45 volts; V4, 2.47 volts; V5, V6, 2.33 volts; V7, 5.60 volts. Plate potentials, V1, V2, V3, 171 volts; V4, 167 volts; V5, V6, 272 volts.

With the tube under test placed in a standard analyzer the following readings may be obtained: Filament voltages, V1, V2, V3, 2.3 volts; V4, 2.35 volts; V5, V6, 2.18 volts; V7, 4.56 volts. Plate potentials, V1, V2, V3, 164 volts; V4, 152 volts; V5, V6, 254 volts. Grid bias potentials, V1, V2, V3, 2.88 volts; V4, 14.7 volts; V5, V6, 48 volts. Cathode potentials, V1, V2, V3, 3.12 volts; V4, 12.4 volts. Normal plate current readings, V1, V2, V3, 3.6 milliamperes; V4, 1.1 ma.; V5, V6, 26 ma.; V7, 60 ma. Screen-grid potentials, V1, V2, V3, 68 volts.

These values were obtained with a line potential of 110 volts, and the power transformer PT set on 110-volt tap, volume control full on and tuning control turned to lowest frequency.

If a bridge is available for measuring the mutual conductance of the tubes to be used in the set, note that a value of 1050 mmhos. is average, 750 mmhos. is low, and tubes reading higher than 1300 mmhos. probably will cause circuit oscillation. Screen-grid tubes having a plate current ranging between 2.5 and 3.1 ma. usually are good ones for this receiver; those reading higher may cause circuit oscillation, and those reading lower may result in poor volume.

In instances where the set has been allowed

to stand idle for some time, it may be found that there is a very noticeable hum in the reproduction; this is an indication that the electrolytic condensers are in need of re-forming. This is simply done by leaving the set turned on for about fifteen minutes, with all tubes except rectifier V7 removed from their sockets. (This puts about 400 volts across the filter electrolytic condensers.) However, the correct forming time will depend upon the length of time the set has been idle; merely repeat performance until correct operation is obtained. The reason the set may act in this way, when first turned on, lies in the fact that the leakage current through the electrolytic condensers has increased appreciably, thus lowering the voltage

the set cover removed. Before attempting to improve the gain of the receiver, it is necessary to see that, when the tuning dial is swung as far as possible to the right, all the condensers are entirely meshed; otherwise, the condensers will not track over the entire tuning range. Should this procedure indicate that one or more of the condensers is not entirely meshed, adjustment of this condenser may be made by rotating it; and for this operation, set screws holding the condenser to the drive pulley are provided.

If it is necessary to adjust the trimmers to an extreme setting for maximum reading on a meter (connected across the voice coil at M), re-adjust them to a more central position and move the serrated plates on the condenser rotors until meter M shows maximum deflection.

An oscillator of somewhat unusual circuit design is recommended as particularly convenient for re-gaining this set; its circuit connections are reproduced here. To complete the connections for the use of this test unit, connect an A.C. voltmeter, with a scale of 0-3, across the leads of the voice coil of the dynamic reproducer.

Next, with a "twisted pair," connect the "Ant." and "Gnd." of the set to the posts provided on the shielded R.F. service oscillator, adjust the oscillator for a frequency of 1400 kc., and adjust the 30-ohm filament rheostat until the voltmeter VM reads 3 volts. Then, adjust the 125-ohm rheostat (which may be a 125-ohm potentiometer connected as a rheostat) until the A.C. meter M indicates 1.0 volt.

Now, insert a screwdriver in the hole provided in the chassis and adjust the compensator on the variable condenser tuning the input circuit of V1, until maximum deflection of the A.C. voltmeter is obtained. Then follow to the next stage, adjusting the rheostat for a 1-volt deflection. Duplicate these operations at 950 and 550 kc.

The Service Man is cautioned to check carefully the line connections to this receiver, if it has become necessary to remove these leads, and to make sure that the connections are in accord with the diagram of the receiver. Otherwise, either a short may result and cause a fuse to blow, or a portion of the primary winding of PT may be burned out.

For proper ventilation (and therefore longer life of the screen-grid tubes) the set cabinet should be placed at least three inches from the room wall.

To check the line terminal plug connections for best operation, follow this procedure: tune in a distant station, reduce the volume, and then very quickly reverse the position of the line plug in the wall plate (before the tubes' heater elements have a chance to cool). Increased signal strength often will be noted in one position of the line plug.

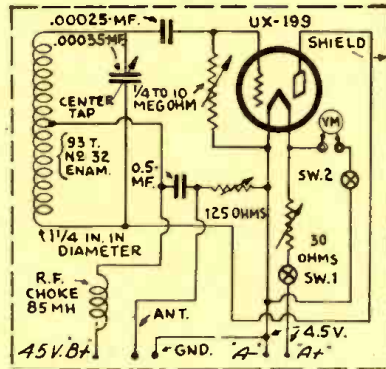

In this modulated R.F. oscillator, the variable grid leak controls the audio note. Voltmeter VM may connect externally for initial settings; the tip-jacks being insulated from the shield. The number of coil turns will vary with the tuning capacity employed; the oscillator may be calibrated against broadcast stations, if desired. The amount of testing signal coupled into the set under inspection is determined by the 125-ohm variable resistor.

on the tubes. Checking the voltages is a convenient way of finding out when the condensers again are fully formed. This forming operation will not be necessary if the set is in operation at least one hour each day.

Each make of radio set has its own particular design, which responds best to certain types of service procedure; and therefore the method of re-gaining the condensers in this receiver (called by the manufacturer "re-gaining the set") will be described.

In no case, when re-gaining the set, should the compensator condensers be adjusted with

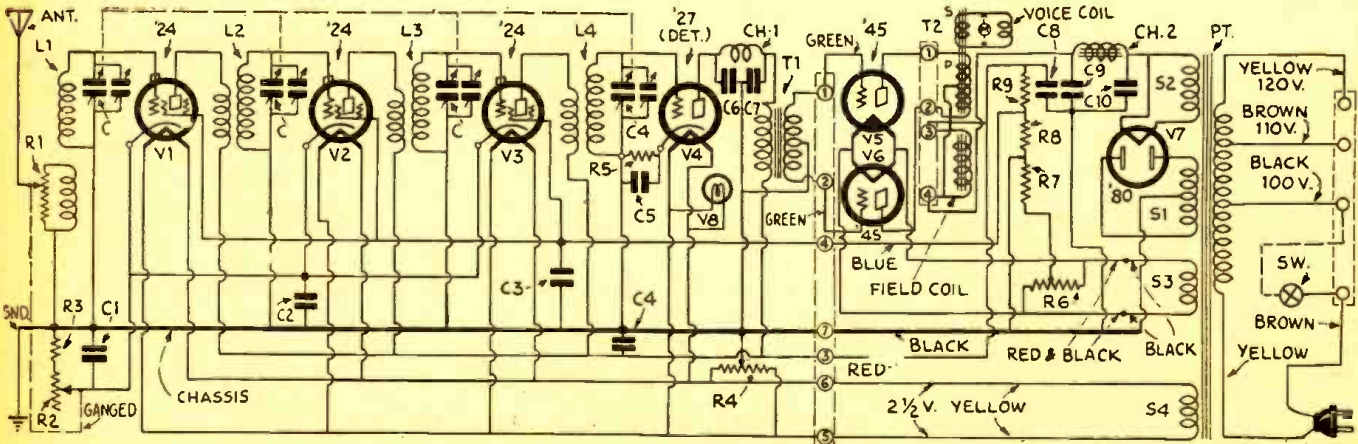



ALL AMERICAN-MOHAWK "MODEL D" LYRIC RECEIVERS

This radio set, manufactured by All-American Mohawk Corp., North Tonawanda, N. Y., is made into a number of different cabinet jobs.

Following are the values of the units in the assembly. Resistors: R1, 10,000 ohms; R2, 7,500 ohms; R3, 200 ohms; R4, R5, 30,000 ohms; R6, 300,000 ohms; R7, 70,000 ohms; R8, 1.0 megohm; R9, 900 ohms; R10, 300 ohms; R11, 1,000 ohms; R12, 2,000 ohms; R13, 2,000 ohms. The gauged tuning condensers are of .00034-mf. capacity; the others measure: C1, C2, 35 mmf.; C3, C4, .05-mf.; C5, C14, 0.5-mf.; C6, .00025-mf.; C7, .0001-mf.; C8, .02-mf.; C10, C11, 1.0 mf.; C13, 1.5 mf.; C12, .073-mf. and C9, 0.5-mf.

The following figures are given as the average D.C. potentials for the tubes in this set when measured, on a high-resistance meter, with the leads on chassis and tube prong. The volume control R1-R2 must be on full-volume position; and the line potential should not exceed 115 volts.

Cathode voltages; V1, V2, 1.6; V3, 5.0; V4, 10.0; plate voltages; V1, V2, 140; V3, 50; V4, 130; V5, V6, 300; screen-grid voltages; V1, V2; 90; V3, 35; control-grid voltages; V5, V6, 50. Filament voltages are: V1, V2, V3, V4, V5, V6, 2.45.

The color code of the resistors in this set is given: R8, black with red end; R6, orange with green end; R7, orange; R4, R5, white; R3, red with black ends.

In this receiver a 24-henry choke coil is used as Ch. 1; it is tuned by C12. In the 25-cycle set, the inductance has a value of 50 henries, and the tuning condenser C12 required (to form a 120-cycle rejector) has a value of 0.2-mf. This circuit arrangement for reducing hum to a minimum should be carefully noted.

The color code for the by-pass condenser block is as follows: 0.05-mf., red leads; 0.5 mf., blue lead. The filter condensers, contained in their metal cases, have a black lead, indicating ground; green lead, 1.0 mf.; soldering lug next to green lead, .073-mf.; lug next to red lead, 1.0 mf.; red lead, 1.5 mf.

The tone control switch Sw.1 is located at the rear of the chassis, next to the antenna and ground binding posts.

The tandem volume control R1, R2, is of the tapered-resistance type, with a hop-off resistance value of 0.15-ohm; and replacements should be of the same design. This low resistance value is necessary to obtain complete control of the volume of the receiver.

The cable tension spring on the tuning control's fabric cable should be stretched to an overall length of 1 3/8 in., or more. Should this

length be less, it may be corrected by shortening the cable. This is most conveniently done by unhooking the spring, tying a knot in the cable, and then again connecting the spring.

Tip jacks J1 are for a phonograph pick-up, which must be connected manually by removing the jumper and inserting the tips. The volume control is turned off.

The R.F. transformers are of special design, and each has a two-section primary. One section is resonated by means of a condenser (C1 or C2) to a wavelength above the broadcast band; the other is effective at the shorter wavelengths. When the shorter wave stations are being tuned in, condensers C1 and C2 act as by-passes; at the longer wavelength both coil sections are effective. The purpose of this "staggered" design is to obtain more even amplification throughout the tuning band.

The screen-grid detector V3 is wired for plate-rectification, and is resistance-capacity-coupled to the first stage of A.F.

Connected to the reproducer is a 4-conductor cable terminating in a plug which is to be inserted in a socket (on the chassis) marked "speaker;" it is A in the diagram. The two primary plate leads from T2 are brown and yellow, the two speaker field leads are red and white; the red one being connected also to the center tap of T2.

Power transformer PT has a 5-volt winding S2, two 2 1/2-volt windings S3, S4, and the usual high-voltage secondary S1.

Filter tuning condenser C12 is within the filter condenser can.

As a matter of record it may be of interest, to some of our readers, to list the equipment suggested by the makers as necessary for outside service, namely; a high-resistance voltmeter reading 0-50-250; a battery and high-resistance meter for continuity testing; a kit of radio service tools; a set of tested tubes for purposes of comparison or replacement with those in the receiver. Where shop service is necessary the following items are recommended: an audio-modulated oscillator for balancing; an output meter (thermo-galvanometer, preferably). The design and use of such units has been given in past issues of RADIO-CRAFT; and a tested dynamic reproducer for this model chassis.

In this receiver model, the procedure in balancing is as follows: connect the output test meter in series with voice coil of reproducer, tune set to approximately 1,500 kc. and tune oscillator to set; of course, placing oscillator sufficiently near set to be heard.

To protect output meter against burn-out, shunt it with a 6-ohm rheostat, which will

serve also to control the deflection. Also, during the first part of balancing the set this resistor may be set to short the meter, and the tests conducted by ear. Greater precision is obtained later by cutting in about one-half the resistance of this shunt.

Now, adjust the trimmers for maximum deflection of the meter, starting from the antenna circuit.

Further balancing should take place at about 1,100, 750, and 570 kc. However, the adjustment is to be made by bending the slotted sections of the rotor plate, slightly, instead of adjusting the trimmer condensers. (For this adjustment a fiber strip will be handy.) To do a real job, the set should be checked again at 1500 kc.

Slightly distorted reception and reduced volume may be due to an open in one-half the secondary of T2; which is conveniently checked by removing one tube and noting reception. It is pointed out that a quick and convenient test of the entire audio system and power supply may be made by checking the performance of a phonograph pick-up connected to tip-jacks J1.

Abnormal hum usually can be traced to troubles which have been described in past issues of RADIO-CRAFT; but, for the sake of completeness these possible causes are given here: filament or heater wires grounded to chassis; socket prongs grounded to chassis by solder; defective by-pass or filter condensers; grounded biasing resistors; unbalanced or defective type '45 tube; defective '80, perhaps with only one plate functioning; open C12; reversed field coil leads; defective detector tube. In the latter instance, a convenient check is to interchange the detector and one of the R.F. tubes. If this clears the trouble, it is not necessarily an indication that the tube need be replaced by a new one, if it functions satisfactorily in the R.F. position.

When checking the receiver for antenna or light-line interference pickup, do not forget, after removing the aerial lead, to short the antenna and ground leads; as the pick-up from the binding posts only may be considerable in some localities.

The recommended antenna length for this set is 85 feet, including lead-in.

If it becomes necessary to replace resistors R1, R2, or condensers C1, C2, C7, or C12, exceptional care should be taken to obtain the correct types and values in the replacement units. In particular, condenser C12 must be exactly right to resonate the circuit Ch1-C12 at the second harmonic (120 cycles) ripple of the 60-cycle A.C. line-frequency.

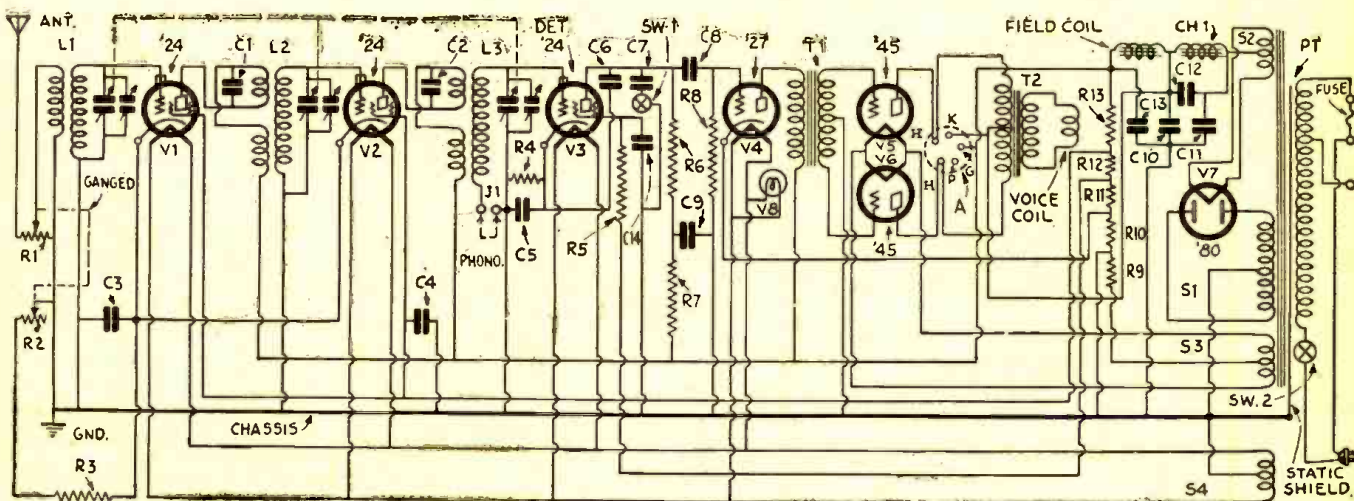

Diagram of connections of the All American-Mohawk "Model D" Lyric screen-grid receiver; a jumper closes the circuit at J1 when a phonograph pick-up is not in use. Tone control is obtained with switch SW.1.



# Principles of Automatic Volume Control

By WALLACE SALZ

RECENT advertisements have played up various methods of automatic volume control. Mention has been made of two-element detection with linear properties, and simultaneous automatic volume control; other advertisements and bulletins refer to the "Multiplex" detector. Still different advertising mentions automatic volume control as a feature, without reference to any one particular arrangement.

Generally speaking, the two-element detector is very much like the system bearing the trade name "Multiplex." Perhaps the word "two-element" is confusing. It means just what it says; although it might be difficult to reconcile the old inefficient two-element detector with modern times. Apparently an obsolete device has been resurrected.

Such is actually the case, except that modern ingenuity has converted that inefficient device into one which enables performance not even imagined when the two-element tube was in its heyday. As such, it is finding wholesale application. It should be understood, however, that reference to automatic volume control does not always mean the two-element tube.

As to the two-element tube itself, we realize that such tubes are available only as rectifiers in the form of the '80 and '81. Reference to the two-element tube as an automatic-volume-control tube means that the normal three-element tube is connected and utilized as a two-element tube. Such a change consists of linking (externally) the plate and grid elements, or of changing the plate circuit return. How this is done will be shown later in this text.

In the meantime, suppose we answer an oft-repeated question. "Just what is automatic volume control?" The question is quite logical, despite the explanatory title. The answer is naturally independent of the type of tube used but, on the other hand, is associated with two other questions, namely: "Does it actually increase the sensitivity of a receiver?" and "Does it counteract deficiencies in transmission?" With respect to what constitutes automatic volume control, we can say that the signal received is em-

ployed to automatically vary one or more operating potentials, and thus cause an increase or decrease in the sensitivity of the receiver. Paradoxically speaking, an increase in signal causes a decrease in the signal.

Such an arrangement differs markedly from the manual forms of volume control utilized in the audio-frequency amplifier; but it duplicates, in an automatic form, the action secured when the grid-bias form of manual volume control is utilized in the radio-frequency amplifier. To say that the same action is secured is of course not doing justice to the automatic system; since the automatic arrangement affords the advantage of minimized physical effort, greater convenience, more rapid operation and, last but not least, more uniform response. Admitting all of the above, the fact remains that the actual means of controlling volume (such as a variation of the radio-frequency grid bias, or of the screen-grid voltage) is the same in both the automatic and the manual systems. In the former, the signal itself is the actuating agent; whereas, in the latter system, it is manual.

## The Sensitivity Level

As to the action of the automatic control upon sensitivity, we are confronted with another peculiar state. The automatic system does increase the sensitivity of the receiver, and then again it does no such thing. It is a matter of viewpoint; just as the manual method of varying the grid bias increases the sensitivity of the receiver, yet does no such thing. In sum and substance, the maximum sensitivity of a radio receiver for any one location is very definitely limited; but a variation in sensitivity is possible between, say, zero and the maximum decided upon in the design of the system.

Thus, neither the automatic system or the manual control adds to the sensitivity of the receiver. Both systems vary the sensitivity between the zero and the maximum determined by design. This means that the use of an automatic volume control will not increase the range of a radio receiver. It will provide a means whereby one may turn the dials and tune in all stations within the sensitivity range of the receiver; which is an action not possible with a manual form of control in the same part of the receiver.

Allied with sensitivity is the subject of the correction of transmission deficiencies. It has been said that the automatic volume control counteracts fading. No such thing! It provides better response during the fading of a signal by varying the sensitivity of the receiver in an inverse manner, thus increasing sensitivity as the signal strength wanes. However, the maximum sensitivity being limited, it is very possible that the signal will fade out entirely; and no amount of automatic volume control will bring it back until the signal strength again increases to the value determined by the design of the radio receiver.

Naturally the automatic form of control enables more uniform response, without the need for readjustment of the manual con-

trol every time a new station with different signal level is tuned in. Thus it may be said that, in a certain manner, automatic volume control minimizes the difficulties caused by fading.

## The Two-Element Detector

We made the statement that the conventional three-element tube is employed as a combination two-element detector and automatic volume-control system. In view of the fact that systems which employ such arrangements are quite numerous, and yet not exactly alike, generalization only is possible. However, these data are sufficiently similar to the actual systems to afford a correct conception of the actions taking place during their operation.

One of the paramount virtues of the two-element detector is its "linear response," by which is meant a certain relation between the input and the output signal voltages of the tube. To be linear, the output voltage must be proportional to the input voltage. Thus, an input signal of twice normal magnitude will provide an output signal equal to twice the normal magnitude. This is in contrast to the phenomenon encountered with the "square-law detector," wherein a two-fold increase in signal input multiples the output four-fold.

At the same time we must give credit where credit is due. The two-element tube, acting as it does, does not amplify; whereas the three-element tube used as a square-law detector, amplifies as well. This, however, introduces no difficulty; since the normal amplification available with the present-day receiver is sufficient to overcome the deficit at this point. As a matter of fact, another amplifying tube is usually used in connection with the two-element detector.

At first glance, one would imagine that the need for another amplifying tube introduces an unnecessary expenditure; but upon second thought, the use of the amplifying detector would make necessary another tube to provide the automatic control. Thus, six of one and a half-dozen of the other. At this stage one would ask, "Why change?" The reason is found in the fact that the two-element tube will handle more input than its three-element relative. As to the use of a tuning meter, both systems could use one to advantage.

## Detector as Volume-Control

Show in its simplest form, the two-element detector is employed as illustrated in Fig. 1. One significant fact must be mentioned: whereas the three-element tube can be used with tuned-input systems, the two-element tube cannot be used with a tuned input system because it increases the resistance of the tuned circuit with the consequent bad effects. Hence the input must be of the untuned transformer-coupled type, or impedance or resistance.

Fig. 1 shows this tube operated in conjunction with an untuned transformer. The grid and plate of the '27 tube V3, used as the combination two-element detector and volume control, are joined. If the second-

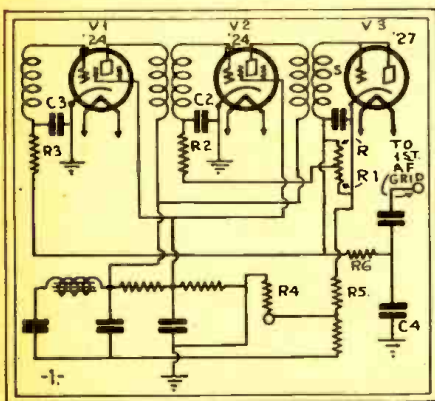

Fig. 1

In this system the regulator tube V3 acts as a two-element detector, the plate and grid being electrically joined.



ary S of the untuned transformer supplies the signal voltage, the complete detector-tube circuit resembles an ordinary rectifying system in an eliminator. The resistors R and R1 constitute the load upon the detector tube and can be classified as the voltage-divider system. The ordinary eliminator filter is omitted.

Referring to the diagram, a signal voltage causes current to flow through R and R1, producing a voltage drop; this current is due to the presence of the signal upon the combined grid and plate, both elements functioning as a common anode. During the positive half of the cycle, current flows between the cathode and anode and, as in the normal rectifying system, this current is present in the load. The drop across R1 is then applied to the grid of the tube marked V2, and the drop across R and R1

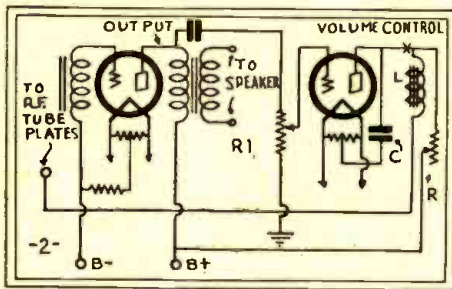

Fig. 2

In the circuit shown here, the volume control is across the output of the power tube. It may readily be applied externally to a set of older model.

is applied to the grid of the tube marked V1. The grid resistors R2 and R3 are ordinary isolating resistances, operating in conjunction with the capacities C2 and C3.

At this point one becomes interested in the normal bias, without any signal input, into the detector-rectifier. This bias is secured from the eliminator's voltage divider, across resistance R4, connected between the grounded point upon the divider and the return to the rectifier.

Examine the circuit; you will note that the cathodes of V1 and V2 return to ground. The path of the plate current, according to normal acceptance, is through the cathode to ground and then through the resistance R4. The drop across R4 is then allied through the isolating resistance R5 through R and R1, to V1 through R3, and to V2 through R2. The A.F. signal is passed to the audio amplifier through R6, which serves to keep R.F. currents out of the A.F. system; this work is aided by the .0001-mf. bypass condenser C1. Such is the action of the two-element detector.

Other Forms of Control

Of equal interest are the other forms of automatic volume control. One such system, employing a separate tube, operates upon the audio-frequency signal as applied across the loud speaker; its control is that of the R.F. plate voltage. (The system is that originated by Williamson of Carnegie Institute of Technology.) The circuit (Fig. 2) is simple in operation, and the control tube is actually a vacuum-tube voltmeter. An examination of the diagram discloses that the plate voltages for the output tube, the control tube and the radio frequency amplifiers are secured from the same source. However, the plate voltage for the radio-

frequency and the control tube is less than that applied to the power tube, as determined by the control resistance R. The plate voltage for the radio-frequency tubes is applied through the choke L located in the plate circuit of the control tube. Any variation of R will naturally change the voltage applied to the control tube and the radio-frequency amplifiers. If, for some reason, the current through R is changed, and the voltage drop across that resistance is increased, the voltage effective at point X will be less than before the increase in current.

Now, if a signal voltage is applied across the output tube's primary, this voltage is applied across the grid and filament circuits of the control tube; since both filaments are common. This voltage causes an increase in current in the plate circuit of the control tube, and reduces the voltage at the point X. This condition results in a reduction of the voltage applied through L to the plates of the radio-frequency tubes. Since a reduction in plate voltage increases the plate resistance, such reduction decreases the amplification available with the tube; because it decreases the mutual conductance of the tube or tubes as the case may be.

The output tube and the control tube are of like character; but, by adjustment of R, it is possible to arrange the characteristic so that the plate current will increase when a signal is applied to the grid. The adjustment of R permits the setting of the control tube for whatever volume is desired. The circuit shows the control tube connected across the output transformer primary; such wiring is not imperative. It is possible to connect the control tube across the speaker terminals; in which case a separate "C" battery is required for the control tube, with correct connection of the volume-control resistance, so that the bias may be applied to the control tube.

It might be well to make a few additional remarks, about the R.F. plate voltage being reduced by the action in the control-tube's plate circuit. According to the diagram, the choke L is in series with the plates of the R.F. tubes and the source of voltage; the same may be said of the resistance R. Hence, any reduction of voltage by an increased drop across R will reduce the voltage effective through L.

One natural advantage of this form of control is that it is possible to apply the control circuit to a completed receiver with minimum changes in circuit structure.

Control by R.F. Carrier Voltage

Another form of control circuit operates by virtue of the action of the R.F. carrier voltage. Such an arrangement affords a distinct advantage over the audio signal control, because it is independent of the intensity of the audio frequencies.

The wiring diagram of such a system is shown in Fig. 3. This is not as simple as Fig. 2, but close examination will clarify points which do not appear clear in the description. Once again, the control tube is a vacuum-tube voltmeter; that is it operates in like manner. The resistors R6, R7, and R8 constitute the eliminator's voltage divider. Now, one peculiarity in this system is the arrangement of the ground potentials and the relations between potentials secured from various points along a divider.

A resistor after all is nothing but a certain type of conductor, and polarity relations exist as much in a resistor as in an ordinary conductor generally classed as connecting wire.

The output of the eliminator is supplied to the plate of the radio-frequency amplifier. One such tube is enough to illustrate the action, and simplifies the complete circuit because it minimizes the number of connection. This R.F. tube secures one bias by means of the resistance R1 in its cathode circuit, connected between the cathode and the ground in the system. Inspection of the eliminator divider system shows a ground at the junction between R6 and R7; apparently the conventional system of grounding the most negative terminal is not used. Since one end of R6 connects to the plate of the R.F. tube, and the other end returns to the ground in the eliminator and to the grounded end of the R.F. cathode, that point is negative with respect to the "high" end of R6.

Now, a point may be negative and positive at the same time; the item of control is the relative point. Thus, the junction point between R6 and R7 is negative with respect to another point along R6, yet is positive with respect to any other point along R7. This means that, if the junction point between R6 and R7 is ground, ground in this case is at a higher potential than any other point along R7. Now, the plate of the control tube connects to the ground, as shown, through two resistances R5 and R4; its cathode connects to the junction between R7 and R8; and the bias developed across R is applied to the grid of the control tube through the resistance R2.

This circuit is somewhat out of the ordinary. The cathode of the control tube is, because of the connection used, negative with respect to ground. But, with the plate connected to ground, this plate is at a higher potential than its cathode and is positive with respect to the cathode; at the same time, it is negative with respect to the cathode of the R.F. tube.

Now, when a signal is applied to the grid of the radio-frequency tube, the radio-frequency voltage developed in the plate circuit of that tube is applied to the grid of the control tube, through the condenser C1. This swings the grid of the control tube, and current flows in the plate circuit of that tube through the resistance of R4 and R5. All audio-frequency current is bypassed to ground, through the capacity C2. (Continued on page 366)

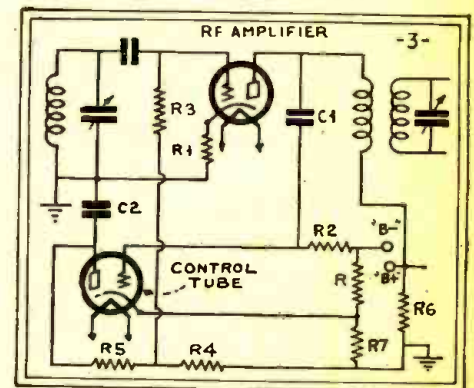

Fig. 3

The circuit above regulates the volume, not to a uniform sound level, but by giving a standard carrier-signal strength, at the detector.



# How to Make a Good Service Oscillator

*The Service Man often asks for details on a factory job. Here it is!*

By K. T. VEDDER and E. C. HUGHES, JR.\*

**A**LTHOUGH service oscillators have been described in past issues of *RADIO-CRAFT*, most of these have been integral parts of rather extensive test sets (such as the "Portable Testing Laboratory" described at length in the January and February, 1930, issues).

This oscillator, pictured in Figs. A and B, and covering a frequency range of 500 to 1500 kc. (200 to 600 meters), is compact and complete in itself. As shown in the diagram, Fig. 1, it may be operated from either an A.C. light line, or batteries; and any tube except the screen-grid type may be used.

## Condenser and Coil

The variable condenser is of .00035-mf. capacity, with a straight-line-frequency characteristic. It is desirable to use a condenser of this type, so that the number of kilocycles per scale division is equal over the entire scale, making more accurate and easier tuning possible.

The inductance consists of 60 turns of No. 24 B. & S. double-cotton-covered copper wire wound on a bakelite form three inches in diameter. A tap is brought out at the mid-point and the coil is painted with either shellac or collodion to hold the windings in place.

The coupling coil, consisting of two or three turns, is wound over the inductance. A lead from one end is brought out to the coupling binding post and the other end is left free.

## Choice of Milliammeter

To obtain an 0-50 milliamperereading with the 0-10 milliammeter, an external

shunt is used. The 0-50 reading is necessary because some tubes draw plate current in this range. The shunt serves also to protect the meter against overloads.

The resistance of the external shunt depends upon the type of meter used. With a Weston "Model 506" milliammeter (0-10-ma. scale) the resistance of the meter is 3.2 ohms. Thus to obtain a reading of five times ten milliamperes, or 50 milliamperes, it is necessary to use an external shunt of 0.8 ohms; since the current divides between the shunt and the meter in inverse ratio to their resistances. The push-button switch is normally closed, placing the shunt in the circuit. By pushing the button the shunt is removed, giving the normal 0-10 milliamperereading. **Current Supply**

The oscillator is built so that either the 110-volt A.C. house supply or "B" batteries, which are mounted in the case, can be used for the plate supply. The "B" batteries are two small 22½-volt units connected in series. A D.P.D.T. switch is connected as shown, to change from one source of supply to the other. This switch is so arranged that it is impossible to place both alternating and direct current on the plate at the same time.

The filaments or heaters may be excited from either alternating or direct current. The changeover is made by a second D.P.D.T. switch connected as shown. This switch also is interlocked, as is the plate supply switch, preventing the application of both alternating and direct current to the filaments at the same time.

When direct current from batteries is to

be used, they are connected to the binding posts marked "External Filament Supply." The alternating current is supplied by a Thordarson "Type 2445" filament transformer. This transformer has three windings of 1.5, 2.5, and 5.0 volts, with mid-taps on the 2.5 and 5.0 volt windings. To supply all types of tubes it is necessary to have the following voltages: 1.1, 1.5, 2.5, 3.3, 5.0, and 7.5. The 1.5, 2.5, and 5.0 volt values are obtained directly from the low-voltage windings. The supply for 1.1-volt tubes is obtained by taking leads from one side and the mid-tap of the 2.5-volt windings. The supply for the 3.3-volt tubes is obtained by connecting the 1.5-volt winding and the 5.0-volt winding so that their voltages are subtractive; as shown in the diagram of transformer connections, Fig. 3. For 7.5-volt tubes, the supply is obtained by connecting the 5.0-volt winding and the 2.5-volt winding in series so that their voltages are additive. All of these connections are shown in Fig. 3, and obtained by means of the tandem 6-point switch.

## Parts Required

The following list gives the make and type of equipment used in the test set as constructed. Other materials can be substituted but care should be taken to observe the necessary requirements.

- One .00035-mf. National variable condenser, and vernier dial;
- One 10½ x 9½-in. bakelite panel;
- One 0-10 "Model 506" D.C. Weston milliammeter;
- One .02-mf. Tobe fixed condenser;
- One 1-mf. Tobe fixed condenser;

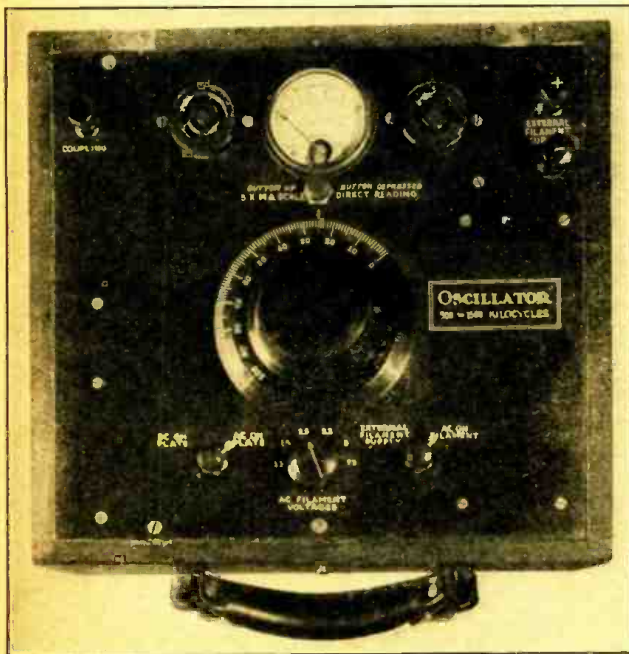

Fig. A

Here is the external appearance of the service oscillator, built as a professional job with engraved panel. Everything is controlled conveniently. The lid is two inches deep inside.

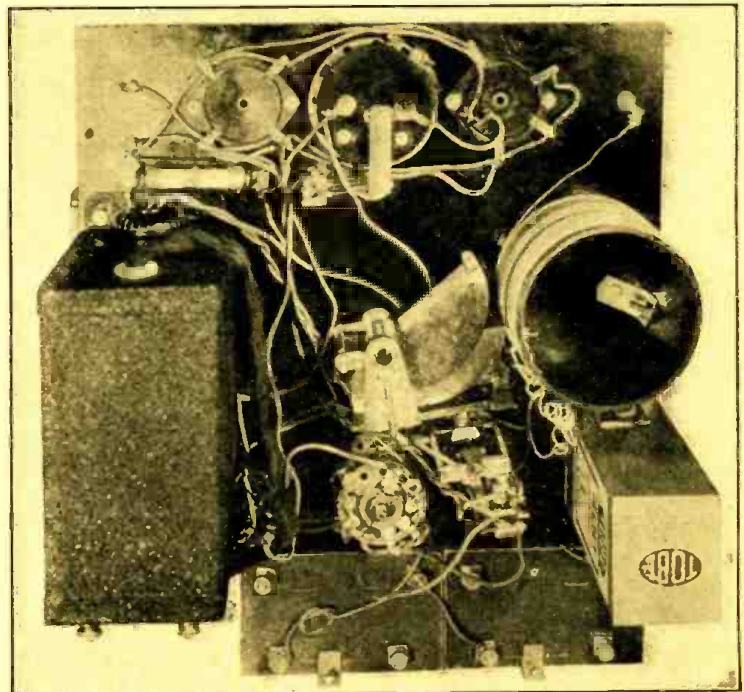

Fig. B

The oscillator is simple enough. Batteries, and a power transformer, with a selector switch, give the choice of any desired voltage.

\* Commercial Engineering and Sales Promotion Depts. (respectively) RCA-Radiotron Co.







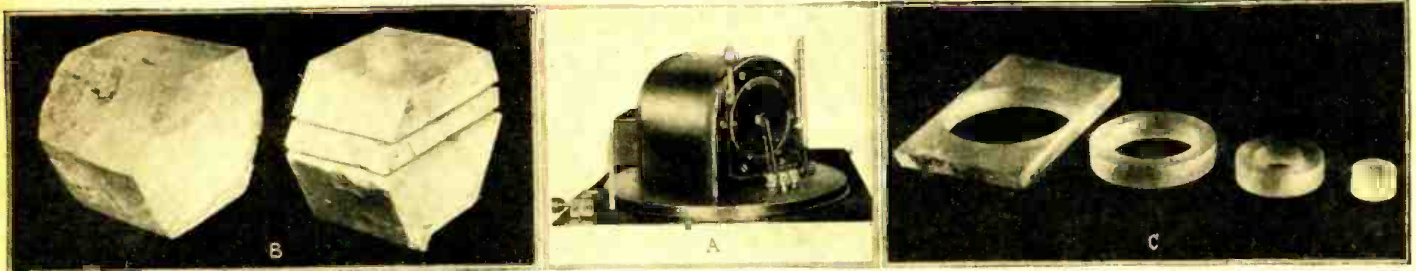

At the left, sections of a quartz crystal, one in the native state, and one sliced to obtain a blank for a control crystal; center, the chamber in which a ring crystal is kept at a regulated temperature; right, a slice of crystal, showing the rings successively cut from it in experimental work. (Illustrations courtesy of Bell Telephone Laboratories.)

# Radio, the Most Exact Timekeeper

**I**N the preceding issue of this magazine, the world's most accurate clocks were illustrated in a page of new radio developments (Page 281, November RADIO-CRAFT). These timepieces, it was explained, are guaranteed to be accurate to one part in a million—that is to say, within thirty seconds a year—but this fraction of error has been greatly reduced in practice, to perhaps one hundredth of that amount. Compared with this, our "Old Reliable," the sun, is a masterpiece of error; for he gets (apparently, at least) as much as 16 minutes out of the way in three months.

It may be inquired what relation these clocks bear to radio; and the answer is that they are operated by radio-frequency oscillators, which are controlled by quartz crystals in the same manner that the carrier frequency of a broadcast station is kept constant. In addition to this, their accuracy is checked up by the application of the heterodyne or beat-frequency method.

It is generally understood by all our readers that a quartz crystal regulates the frequency of an oscillating circuit; but the exact method may not be understood. It may be explained that this regulating effect is not confined to quartz, or rock crystal (as it is often called); many other crystals, such as Rochelle salts, may be adapted to the purpose, but quartz is the hardest and most durable of substances readily obtainable.

### Operation of the Oscillating Crystal

A crystal is a homogeneous substance; that is, it is composed throughout of atoms and molecules symmetrically arranged. In the case of quartz, the components are silicon and oxygen, in the proportion of two atoms of the latter to every one of the former in each molecule. When an electrical force is applied to the crystal, the arrangement of the molecules is slightly altered, and consequently, to a very slight extent, the crystal is put under physical tension. When the field alternates, the crystal elastically returns to its former dimensions. The action

is exactly similar to that of the weight, supported by a spring, which is the classic explanation of a tuned radio circuit. If an alternating current, of exactly the frequency at which the crystal will naturally vibrate, is applied to the crystal, the effect is maximum; and, even though the current is slightly off the frequency of the crystal, the latter will still tend to vibrate at its natural frequency, and may therefore be used to correct the frequency of the applied current to agree exactly with its own.

This action, like that of the pendulum of a clock (the natural frequency of which depends upon its length and the force of the earth's gravity) may be applied to regulate a timepiece. But, while the pendulum swings once, or even two or four times a second, the almost infinitesimal molecules of a crystal can complete an oscillation in a millionth of a second or less.

Other examples of regulators are the tuning fork, which may be arranged to govern an electrical circuit, at fairly constant frequency, up to a pitch far above audibility; and the "magnetostrictive vibrator," in which the molecular movement of the particles of a metal like iron or nickel, in an alternating magnetic field, has a natural period of vibration which also may be utilized. But the crystal is in many ways superior to all of them in the degree of accuracy which may be obtained.

One element is especially important: any crystal which is cut to a regular shape has a natural frequency of vibration, which remains unchanged only while the crystal is kept at the same temperature. If the crystal becomes warmer—and its continual internal oscillation always tends to create heat, which is only a motion of molecules—its vibratory period will change. It is therefore necessary, when using the crystal as a time-keeper or a frequency regulator, to provide some means of keeping it at a steady temperature. In Fig. A we see the cylindrical chamber which houses the crystal of one of these clocks; this chamber, furthermore,

is kept under a bell jar in a room whose temperature is also carefully regulated.

### Precautions Against Changes

In the heart of this cylinder, the crystal is mounted between two electrodes, which serve to connect it electrically to its circuit. It is spaced from them by paper, and they are spaced by pyrex glass. The crystal is then wrapped in 1/5-inch of felt and placed in a cylindrical aluminum shell, the end of which is closed by a screw-plug through which the leads are taken. The aluminum, which is an inch thick, is an excellent conductor of heat; over it are wound heating coils, which are also applied to the ends. Outside these are applied four layers each of felt and sheet copper, spirally wound (like a paper condenser). The whole is governed by a thermostat; so that the temperature change on the outside is less than 1/27th of a degree Fahrenheit, while that reaching the crystal is very much less.

Since the natural frequency of the crystal varies, not only with its temperature, but also with the atmospheric pressure surrounding it, the whole assembly is kept beneath a bell jar, at a pressure slightly below that of the surrounding atmosphere. An air pump may be applied when necessary to compensate for any leak of air into the jar; and the rate of the clock's running may be regulated by increasing or reducing the pressure slightly. Each 10 centimeters of pressure (about one eightieth of normal atmospheric pressure, measured on the column of a mercury barometer) alters the rate of the crystal's vibration about one part in a million. A thermometer under the bell jar shows the temperature, and consequently the change of pressure due to heat, of the air in the control chamber.

### Crystals Cut Into Rings

In the endeavor to make crystals of uniform frequency, affected least by the minute changes of temperature, after all these precautions, circular discs were cut from a quartz crystal and tested. The interesting

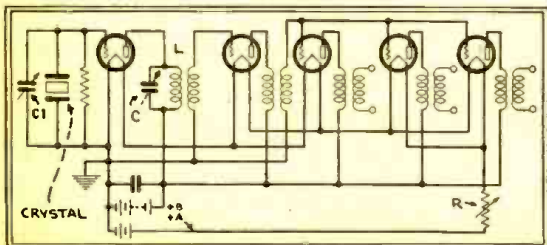
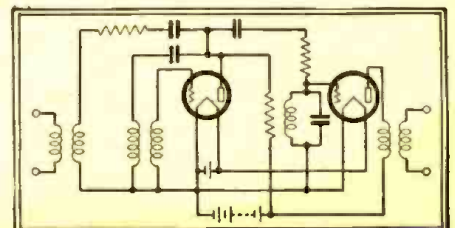

Fig. 3  
At the left, the amplifier circuit connected to the crystal, which is shunted across the grid of the first tube. The little condenser C1 is a vernier, permitting very fine adjustment of the circuit. There are three parallel outputs.

Fig. 4  
The circuit at the right is so tuned that it generates a frequency which is any determined "sub-multiple" or factor of its input frequency.





fact was then shown that, while the smaller the disc, the less its frequency is affected by heat, the ring-shaped blanks from which the smaller circles were cut are superior to either. The crystals finally adopted, therefore, are rings, as shown in Fig. C. Such a ring is mounted upon a horizontal cylinder, which it touches only at a central point (Fig. 1). Here the vibration of the crystal is less damped than at any other possible point of contact.

For this purpose, it may be stated, all quartz is not suitable. Only very clear, pure grades are used; and these must be cut at a certain angle between their "optic and electric axes." The optic axis extends lengthwise of the natural crystal, while the electric axes, three in number, are perpendicular to it, and spaced 120 degrees apart.

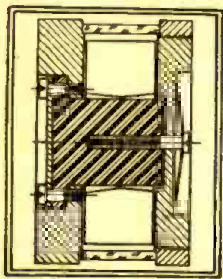

**Fig. 1**  
The method of mounting a ring-shaped crystal around a central core, so that it has the greatest freedom of vibration. The crystal, shown in section as a white area, is spaced from its electrodes by paper. The electrodes are separated by a glass ring insulator.

(Fig. 2) For a more technical explanation of methods of preparing crystals, the reader is referred to the February, 1930, issue of *The General Radio Experimenter*.) The cutting and grinding of a crystal to a definite frequency is a very delicate operation, comparable with the best art of the lapidary.

When a crystal is used to govern the operation of a radio transmitter, modern practice is to select one having a frequency considerably lower than that of the carrier; and then to amplify its harmonics until the desired frequency is reached. For instance, a crystal with a frequency in the order of 1,875 kilocycles may be used; the second harmonic of its output, 3,750 kilocycles, is amplified; and finally the second harmonic of this, 7,500 kilocycles, governs a 40-meter high-power oscillator. The result is that modulations effected in the output circuit cannot react upon the master oscillator.

**"Gearing Down" the Frequency**

In the clock described, however, we have a 100,000-cycle oscillating crystal, of fairly large dimensions; but, instead of stepping up its frequency, we desire to step it down until it is in the order of the movements of a clock gear.

The master oscillator (Fig. 3) controlled by the crystal at the left, has an output loosely coupled to three independent output amplifiers which are free from mutual interference. Each output gives a standard-frequency 100,000-cycle pure note, which is transferred to a "submultiple generator" circuit.

The submultiple generator is the exact reverse of a harmonic amplifier; its fundamental frequency (10,000 cycles) is only a tenth that of the input, which therefore corresponds to its tenth harmonic. It consists of an inherently unstable vacuum-tube oscillator, operating on the curved part of its characteristic, and which may therefore be controlled by a frequency which is a multiple of its fundamental (See Fig. 4).

The output of the 100,000-cycle amplifier is resistance-coupled into its plate circuit; and the result is that the output of the submultiple generator is definitely controlled at 10,000 cycles. A second arrangement of this type steps down the 10,000-cycle output to 1,000 cycles; and a 1,000-cycle motor, controlled by this, drives 100- and 10-cycle generators. The accuracy of the ultimate output is equal to that of the original crystal control.

In addition to this, the 1,000-cycle generator is geared directly to a clock, which keeps step with it. The accuracy of the clock, when checked by standard time signals, therefore indicates the accuracy of the crystal, which may be regulated by its temperature, the air pressure around it, and the trimming condenser in shunt with it.

**Methods of Comparing Times**

Before describing the method of comparing the clock with time signals, it may be of interest to explain the way in which the latter are obtained. As said above, the sun does not keep accurate time—or, to put it more exactly, the earth revolves around the sun in an orbit which is not circular, and at varying speeds—so that from noon to noon is never exactly twenty-four hours. The astronomer, therefore, makes his observations on the stars. The time of the earth's rotation on its axis is almost exactly 23 hours 56 minutes and 4.01 seconds of ordinary time (not 24 hours); and this unit of time, so far as we know, varies less than any other standard of measurement which we have. The astronomer checks his clocks by the passage of stars over the north-and-south line through his telescope and, in this manner, corrects them daily. This is the basis of the time signals from Greenwich,

Washington, Paris, and other great observatories.

When comparing a time signal with a clock, no observer can do so instantaneously. To hear and recognize a sound, and to check it against a clock, takes about a fifth of a second; and this is not sufficiently quick for timepieces of the accuracy of those which we have described. A double recorder is used instead; the 1,000-cycle motor operates a cam, which makes a mark on a tape once a second. When time signals are received, by wire, a printing telegraph also marks the same tape; and the difference in time between the two ticks may be measured mechanically. (For absolute accuracy, in this order, it is necessary also to take into consideration the time consumed in the transmission of a signal by telegraph, even though it is but a slight fraction of a second.)

In the large illustration (Fig. D) we see four master oscillators, each in its cabinet, mounted side by side in the Bell Telephone Laboratories in New York City. Three of them are adjusted as nearly as possible to the same frequency; the fourth is out of step to the extent of one in a million, or one cycle every ten seconds. The result is that, when the output of any one of the first three is selected by a switch and compared with No. 4, beats are set up. In a period of a thousand seconds (16 2/3 minutes) these beats are automatically recorded; there are approximately a hundred of them. Frequent comparisons are thus made of the three first oscillators. Small variations between them from time to time are unavoidable; but this random variation, at the rate of a second or two in a hundred million, is almost unimaginably small. It

*(Continued on page 368)*

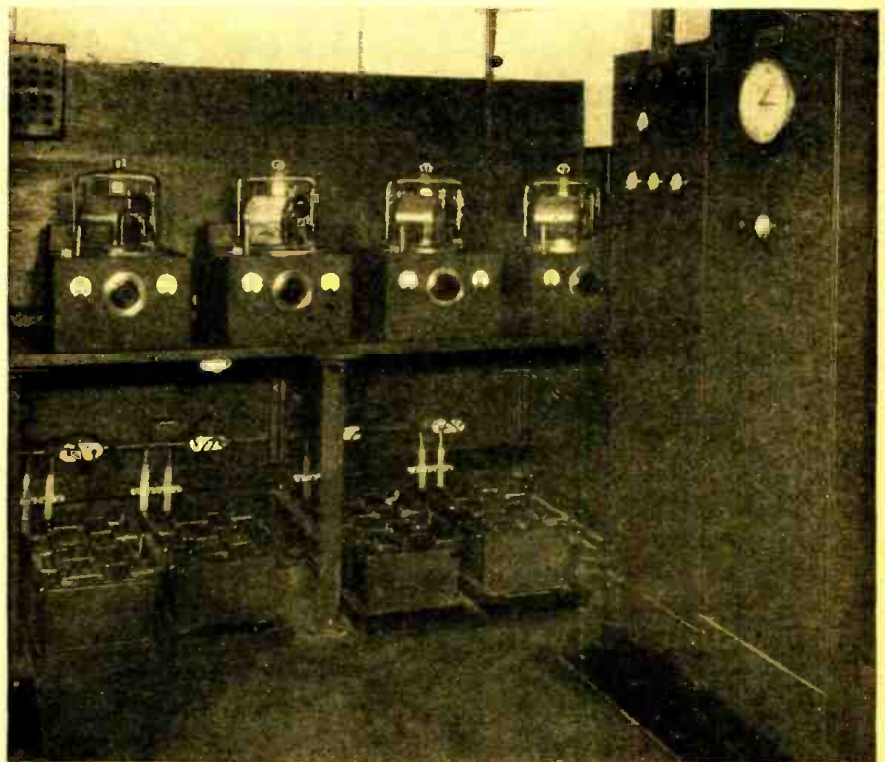

**Fig. D**

The room where the electric clocks are kept; four are shown in a row at the rear. The crystal is kept in the cylinder, in each bell jar, and its amplifier is in the shield can below. The submultiple generators are in the cabinets at the right.



# Home Recording of Radio Programs and Speech

By R. D. WASHBURNE

**Y**ESTERDAY you bought your phonograph records; today, you make your own. That is, you do so if you have purchased one of the new radio sets which include that little 4-way switch marked "radio, phonograph, radio-recording, home-recording."

In fact, the wonders of home-recording are now available also to anyone purchasing one of the recently-marketed home-recording "kits," intended for use in conjunction with a standard radio set and phonograph.

An example of the complete ensemble of radio, phonograph, and home-recording equipment, is illustrated in Fig. A. This is the Radiola "86" (electrically equivalent to the General Electric "1171"; Westinghouse "WR-7"; Graybar "900"); its radio chassis is wired substantially as shown for Radiola "80" in Data Sheet No. 29 (November, 1930, issue of RADIO-CRAFT). In addition to a tone output control, there are the following units: hand microphone, phonograph turntable and motor, electromagnetic pickup, and a switching system whereby the same pickup (equipped with a special blunt needle) may be shifted, from the usual reproducing position at the *input* of the audio amplifier, to the *output* of the audio amplifier for recording.

As previously mentioned, a kit of necessary additional parts may be obtained for home-recording where the radio set and the phonograph are already available. Such a set of components is illustrated in Fig. B.

## Pioneer Electrical Recording

This is a far cry from the famous home-recording work of Charles E. Apgar, the "pioneer home-recorder," who, in October, 1913, recorded his first radio transmission; "press" from the Herald station. An elec-

trical amplifier, working on the principle of the microphone, was used in this work. A picture of the apparatus is shown in Fig. C.

Two years later, Mr. Apgar's records, made for the United States Government, resulted in putting WSY, the huge code station at Sayville, L. I., off the air; after it was seen that irregularities existed in its wartime transmissions to station POZ

**H**OME-RECORDING is the latest adjunct to radio and has already reached a commercial stage such that the radio dealer and the independent Service Man can now cash in on this new feature.

Home-recording is likely to take the country by storm, as soon as the public awakens to its possibilities. Parents would like to preserve the voices of their children—and children in turn will be anxious to preserve the voices of their parents and grandparents; so that the spoken word will remain after the little folks have grown up, or the old have gone.

A good deal of money can be made by installing such home-recording sets in homes; and the present article—the first of an authoritative nature to appear in any radio publication—brings together under one head the better-known recording apparatus now on the market.

in Nauen, Germany. It is interesting to observe the comment of Dr. Karl Georg Frank, general manager of the Atlantic Communication Company (Telefunken), under date of July 18, 1915: "The statement



Fig. A

The "Radiola 86" combination radio-phonograph with home-recording attachment and tone control; a 4-way switch selects the service. The young lady is making an "audio snapshot."

that Mr. Apgar can record messages sent out by wireless on a phonographic cylinder is hardly worth disussing. That is physically impossible. I have never heard of its being done. If Mr. Apgar has accomplished it he should get his idea patented and perhaps we will buy it." (!)

That the "physically impossible" now may be accomplished by anyone is a result of the following present-day developments: audio power amplifiers; an electromagnetic pickup which may be connected to the output of an audio amplifier, and thus driven as a recorder (as well as to the *input*, for reproduction); inexpensive metal and cellulose record blanks.

Of course, it has always been possible to make personal recordings, of a sort, simply by shouting through a megaphone and into the "flare" of an ordinary phonograph. That type of recording was done with the earliest phonographs. But "electrical recording," now so convenient to everyone, results in greatest volume and quality with least "needle scratch."



Fig. B

The "Presto" home recording kit (pictured in detail at right); the recording head is being put in operating position. A popular make of modern radio is the "accessory."

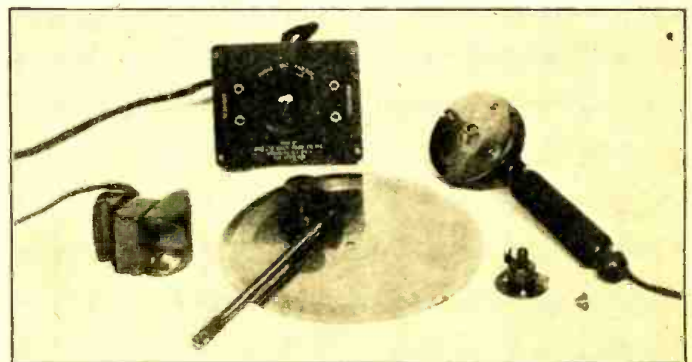

A complete kit of parts for use with any radio-phonograph combination; this includes a heavy recording head (leather V-way at left of needle-holder); hand microphone; ungrooved Emerson-Wadsworth double-faced record blank; feed-rod and center-post clamp; end-rest; and, in the background, the 4-way circuit-changing switch-box, provided with tip-jacks for recorder and microphone leads.



### Method of Operation

Naturally, the better is the audio amplifier, the better will be the recording and the reproduction; and, where a radio program is the subject of perpetuation, the greater will be the need for near-perfection in the R.F. and detector units.

The choice of microphones used for personal recordings, too, is a most important consideration. Replacing a low-priced "mike" with one of better design will result in much better records.

In this connection it might be mentioned that microphone technique, as practiced by the most successful artists on the air, is a desirable study when the best results are wanted. Even a poor "mike" may be made to do wonders, in the hands of a person who understands its characteristics and use.

The circuit arrangements used by different instrument makers are not identical in every instance; but the general scheme of each recording system is shown in Fig. 1. Where an automatic switching system is not used, the following circuit variations may be noted. The tip jacks J1 are provided on most sets, in which they are marked "Phono. Pickup," or just "Phono." Two other tip jacks, J2, should be connected to take the output of the last stage of A.F.

Now we are ready to put the home recorder into operation. The first thing to be decided is whether a radio program or a personal recording is to be made. If the choice is for radio, the R.F. chassis is adjusted for best response from the selected station; while, if the recording is to be personal, a microphone is wired into the input circuit of the detector or first A.F.

Next, a phonograph pickup or a specially designed recorder is connected to the output of the audio amplifier, at J2; and the turntable started. Whether the recorder is to be connected to the primary or the secondary of the output transformer will depend upon the design of the "recorder."

### Types of Pickups

For instance, the 3-lb. "Presto" recorder is specially designed to connect across the low-resistance voice coil of a dynamic reproducer, as shown in the illustration. The "Audak" phonograph pickup is obtainable with an 18-oz. weight fastened to it for recording, and this pick up (now to be used as a recorder of the high-resistance type) is to be connected across a high output impedance, such as the primary of an output transformer. Whether pickups of other makes require to be weighted for recording is best determined by trial. The R.C.A. pickup, is weighted for recording, but the weight is only about eight ounces.

On completion of the record, the set may be detuned, in the one instance, or the "mike" disconnected, in the other; and the recorder is then disconnected from J2.

If this same recorder is now to be used as a reproducer or phonograph pickup, it is connected to the tip-jacks J1; otherwise, a standard pickup, provided in some instances, is connected here and the record played back.

Obviously, a switch may be arranged to make these circuit changes when shifting from recording to play-back; or this may be accomplished manually by shifting leads. The switch idea has been applied by R.C.A.;

the single pickup being used as a "duplex." The switch for circuit-changing is used also in the "Sentinel Chromatrol"; a special electromagnetic "recording head" is carried along a threaded rod for the purpose of cutting a groove in each blank record and inscription, and a regular phonograph electromagnetic pickup is used for play-back.

A complete kit product is the "Presto" illustrated on the cover of this issue. An electromagnetic "recording head" is carried on a threaded rod for grooving and inscribing ungrooved records.

An interesting feature, which lends greatly to the convenience in use, is the manner in which the recording head is arranged to engage the threaded rod. A pad of leather separates the head from the rod; but, at the same time, the threads sink into this



Fig. C

*Mr. Charles E. Apgar, the "radio detective," home-recording high-speed telegraphy from POZ in 1915. In appearance, the mechanism is similar to the familiar office dictaphones for stenographers; except that an electrical output is used in inscribing the wax "cylinders."*

leather, grip it, and cause the head to be pulled along. Consequently, to remove the head for play-back with the regular pickup it is necessary only to lift it off the rod and set it aside; the acme of ease.

The winding of the recorder's electromagnetic, which is of low resistance, should be connected across the voice coil of a dynamic reproducer. Variations, within rather wide limits, are said by the manufacturer to

cause little difference in quality of the recording. As the illustration shows (Fig. B), a small box, having a switch marked "Phono.—Mic.—Radio—Rec." is supplied for switching circuits; a hand microphone, with off-on switch, is also provided.

Several models in the "Audak" line of pickups are recommended by the makers as suitable for recording purposes, when the suspension arm is loaded with an 18-oz. weight. The "Musichrome" unit, made by the same concern, is suitable for use where a radio is available but not a phonograph; for it includes a self-starting induction motor, turntable, and electromagnetic pickup. These are housed in a small walnut cabinet, measuring 11 x 11 x 7 in. high, and ready to be connected to a separate power amplifier or to a radio set.

### Records and Their Use

At the present time there are available record blanks of pre-grooved metal, un-grooved metal, and pre-grooved cellulose ("non-breakable," flexible black cardboard-like ones with a waxy surface). Some of the metal records (zinc, aluminum, or aluminum alloy) are single- and some double-sided; the cellulose discs are double-sided. The cellulose records, which will shortly be available in every town and hamlet in the country, through the efforts of the R.C.A., cost but a few cents. Like the metal records, their playing time is about one to three minutes; since they have a diameter of six to seven inches.

If the pickup suddenly cuts across the record, or keeps repeating at one point, it is probable that either the pickup is not properly placed, the wrong needle is being used, the record was not dusted off (to remove foreign particles) before the recording was started, or the audio system was allowed to overload the recorder and cause too great a lateral cut on a loud note.

If the reproduction of records made with weighted recorders is off-pitch, it is an indication that the motor is overloaded; and it will be necessary to speed up the turntable for the next recording. A little practice will indicate the correct positions of the turntable speed control for recording and for play-back. A "stroboscope" is another and more accurate solution of this problem; as this device will indicate exactly the instant when the turntable has reached its standard speed of 78 r.p.m.

Some of the records may be played back (ordinarily, 20 to 50 times) with the same

Fig. D

*The "Sentinel Chromatrol." The 3-bar feed is supported at the center of the turntable, and moving the knob in the center of the recording head raises the needle from the record. Recessed switches in the top of the mounting board control the circuits for play-back, which is accomplished through the pickup shown in the upper right-hand corner. This assembly may be obtained complete with radio and remote control; at the moment, the "last word."*

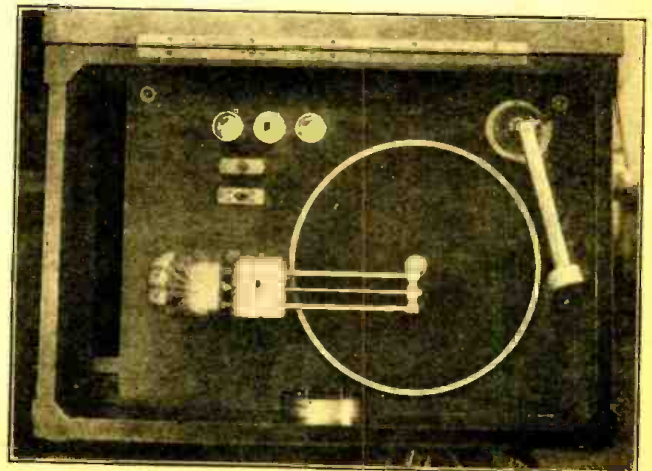



needle that was used for recording; others require a different needle, "soft," blunt, or fiber, for play-back.

A number of uses, both amusing and practical, for these records, should suggest themselves to the "home recordist."

For instance, it will be amusing to mail personal recordings to friends in lieu of a letter; and it would be most practicable to record "ideas" as they occur to you. In fact, these little "audio snap-shots" might prove very valuable at a later date.

The boy friend now can send the girl friend a *real* love letter.

Visitors will be delighted to make a short "personal recording" for you. And it is possible to record a radio program or personal act, more lengthy than a single record will hold; perhaps through the use of two turntables, two pickups duplexed for recording, and a potentiometer for "fading" from one to the other (as described in the

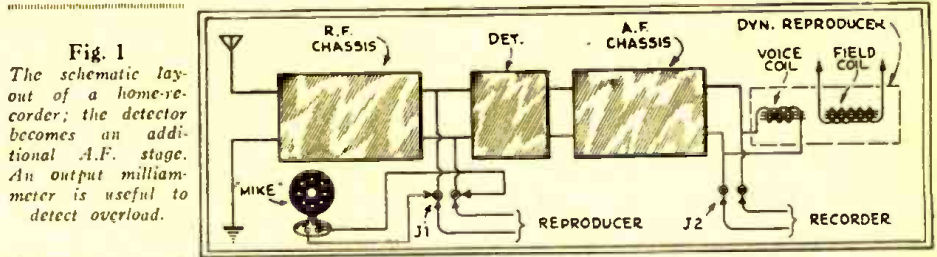

**Fig. 1**  
The schematic layout of a home-recorder; the detector becomes an additional A.F. stage. An output milliammeter is useful to detect overload.

March, 1930, issue of RADIO-CRAFT, page 455).

If you are using a public-address adopter of some sort (see the details of an excellent design published in the October, 1930, issue of RADIO-CRAFT, page 218), you may now make your own carefully-worded sales record for what might be termed "spot broadcasting," and rig it up with one of

these repeating mechanisms to play the record continuously in your absence.

Instead of sending to your radio prospects an ordinary circular letter concerning one of your special offerings, indicate to them that you are modern in your ideas and methods by sending them a personal recording, with the admonition, "Try this on your radio-phonograph."

## New Antennas "Directional" at High Angle

THE fairly-established theory of short-wave propagation, that the transmitted wave from a station divides into two parts—one following the curve of the earth, and the other traveling into the sky, whence it is again reflected from the Heaviside layer—has been extensively utilized in practical (commercial) telegraphy and telephony. For the very short waves used in communication between the two Americas, or between either and Europe, and from Europe to the Far East and Australasia, directional transmitting antennas have been erected, which serve as gigantic reflectors to concentrate the emitted waves in the direction of the special receiving stations, thousands of miles away. At the receiving stations, similar antennas have been erected, to pick up the received wave in proper phase on a great many wires. While the efficiency of these reflectors cannot be compared to that of a mirror in focusing light, they greatly increase signal strength. It is true that, because of their great size, they are not flexible. Once placed, an antenna covers only a certain sector; for each line of communications, a pair must be constructed, one at each end. But they have made possible reliable service at comparatively low cost.

With ultra-short waves, below five meters in length, the "ground wave" is practically eliminated; and, since the sky wave is apparently not reflected back to earth, it must be received on the way out to the horizon. With waves slightly longer, while the ground

wave does not cling to earth, the sky wave comes down again; and thus stations of low power are received at great distances.

Experiments have been made on short waves, to change the angle at which the wave is sent up into the sky, and thereby alter its "skip distance" (see Fig. 1); but the principle has only lately been borrowed from the short waves for use on the regular broadcast band.

In the new broadcast plant of the Westinghouse Co. at Saxonburg, Pennsylvania, which incorporates Station KDKA and its associated short-wave transmitters, a novel idea has been applied—that of the "spray" antenna. The purpose of this is to eliminate, so far as possible, the ground wave; and to send out broadcasts in such a man-

ner that, while the field is weakened in the immediate locality of the transmitter (where it would be normally too strong for the comfort of the listeners) it is strengthened over a larger area. The principle is illustrated

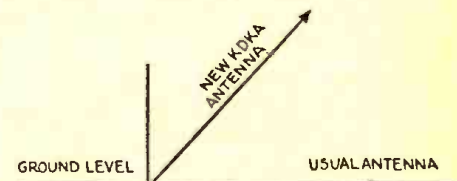

**Fig. 2**

The purpose of the "spray antenna" is to project the sky wave at the angle to the horizon which will give the largest service area.

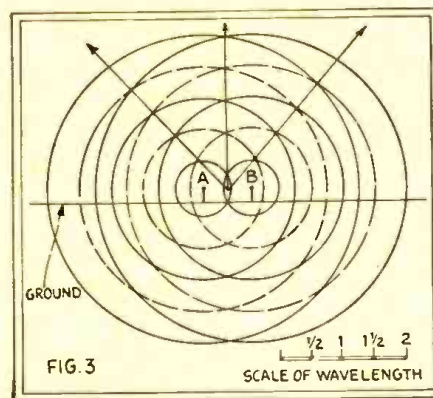

**FIG. 3**

Above, a representation of the "spray" field; with antennas about a three-quarter-wavelength apart, the phases will be found strengthened between the angular lines.

**Fig. 1 (left)**

The progress of a radio wave and its division into a "ground" and a "sky" wave is indicated here; it is the "sky" wave which gives distant reception.

fundamentally in Fig. 2; it may be compared to elevating the muzzle of a gun in order to make it carry further.

Both short- and long-wave spray antennas are used; the latter are larger in dimensions, necessarily, because of the longer radiators required. The system contains eight 100-foot wooden masts, spaced in a circle about 700 feet in diameter, which suspend a cage top running around them. These eight sections of the antenna are energized from the center, by individual feeder lines running to each pole. The result is that the lower parts of the radio wave, which travel inward from each cage strike each other, and tend to cancel; while the upper parts of the waves travel out into space at an angle to the horizon, re-enforced in phase. The whole suggests the common circular garden sprinkler in its action—whence the name.

In the short-wave structures the same principle is followed, except that, for technical reasons, the eight distinct antenna lines are perpendicular, each on its mast, and connected to the feed-line at its center. The new system is the invention of Dr. Frank Conrad.

The new system will be tested especially by the fact that KDKA is to use more power, for special tests, than has ever before been put into a broadcast antenna.

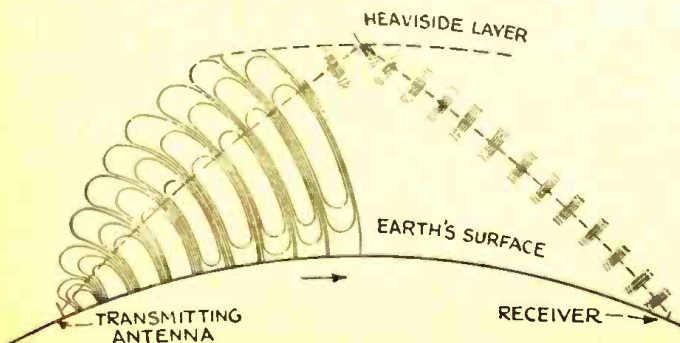



# New Radio Devices for Shop and Home

In this department are reviewed commercial products of most recent interest. Manufacturers are requested to submit descriptions of forthcoming developments.

## QUADRUPLE VOLTAGE-REGULATOR TUBE REPLACES VOLTAGE DIVIDER

By Dr. F. Noack (Berlin)

IN every electrically-operated set, where the plate and grid potentials are obtained from taps in a resistor system (whether in parallel or series arrangement) the applied voltage values vary with those of the currents flowing through the respective resistors, and especially with the plate current of the power tubes. In addition to this, the by-pass condensers across the resistors, required to reduce A.C. resistance and eliminate undesired circuit coupling, add to the cost of the power unit. In many cases, set designers find it preferable to use "C" batteries to avoid fluctuations in grid bias. Also, adjustment of voltage taps with ordinary voltmeters is difficult, because of the low resistance of the measuring instruments, compared with that of the resistors to which they are applied.

These difficulties have been overcome to a large extent in a very interesting manner in the new glow-tube potentiometer produced by a German firm, which is illustrated in Fig. 1. Voltage-regulator tubes are familiar on the American market, but these preserve a constant voltage across only one pair of terminals. The new bulb has five cylindrical metal electrodes, nested one over another, and may be mounted in a five-prong tube socket of a standard European type.

The sketch at the right shows its use as a voltage-divider: between each of the four pairs of electrodes, a potential difference of 70 volts is maintained, with a variation of not more than 2 per cent., which is negligible. For the varying grid biases, external parallel potentiometers may be conveniently used, as shown, to give any negative values between 0 and 70 volts.

The alternating-current resistance of the tube, between any adjacent pair of electrodes, is not more than 20 ohms, or in the order of a large by-pass condenser. It therefore serves as voltage divider and filter combined.

The uses of this device, obviously, are not confined to radio reception; but it may be used with any apparatus where it is necessary to maintain at a constant value voltages derived from a light-line supply. Vacuum-tube voltmeters and wavemeters and other laboratory apparatus utilize the same action to advantage. The tube is made by Osram and distributed by Lorenz, of Berlin, together with a "B" power unit of 120-milliamperes capacity in which it is incorporated.

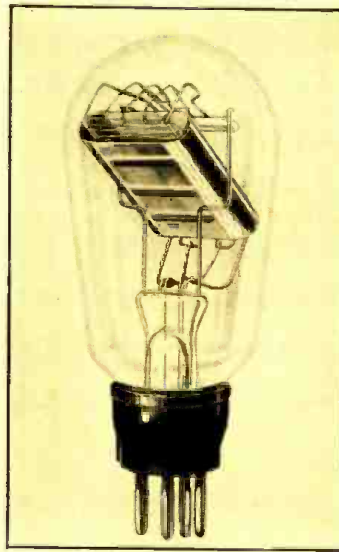

A power tube of typically British internal construction, of very high mutual conductance, for use on low voltages.

## BRITISH OUTPUT TUBE FOR D.C. SETS

ONE of the matters in which foreign observers are apt to cast stones at American radio practice is that of our limited range of tube types. They have an enormously larger number of varieties from which the set builder may select; and economy of operation is a matter which concerns them greatly. Without going into the rebuttals which American tube manufacturers may offer, as to quality, high evacuation, and cheapness, it may be remarked that we have a much stronger tendency to concentrate on the use of a single type of tube—the '99s and then the '01As in battery days—the '27s and the '24s now. When conditions do not permit of their effective and economical use, the standard sets rather tantalize the prospective radio user.

For instance, the areas served by 110-volt direct-current house lines are limited, but include a great many households. While direct-current sets have been constructed, the limiting factor of plate voltage prevents obtaining a large output, except by grouping power tubes—an expensive and none too satisfactory proceeding. No tube has been made available in America to meet this demand.

In Great Britain, on the other hand, an

enormous number of houses are served with direct current, from 110 to 220 volts, and we are interested to notice the production of a recent tube well adapted to power work on low voltages. The Marconi "PX-4" tube has an impedance of 1050 ohms; with a mutual conductance of 3300 micromhos, or twice that of the American '10 and nearly twice that of the '45. Its amplification factor is 3.5, and its maximum plate current 50 milliamperes. The tube is rated as able to dissipate 10 watts on the plate.

With a grid bias of ten volts and a plate voltage of 100, the tube's plate current is 34 milliamperes; and, with the maximum of 200 on the plate, a 45-volt bias adjusts it to 45 milliamps. of plate current. The tube's filament consumption, 60 milliamperes at 4 volts, is equivalent to that of one of the new type '31s, and less than that of the '20 in wattage. Its appearance, characteristic of British tube construction, is shown in the accompanying illustration.

## A NICKEL A NUMBER

FIFTY cents an hour is the rate for metered radio programs through the coin-in-a-slot device shown in the illustration, and which makes any set a pay-as-you-go affair when it is connected between the set's socket plug and a sixty-cycle power source. The "Best Way Radio Control," as it is called, contains a little synchronous motor, which runs exactly six minutes when a nickel is inserted in the slot. This mechanism, the "Synchrin" as it is called, turns on the receiver at the beginning of that time and, at its close, shuts itself off as well as the power input. It is intended, of course, for restaurants and other public places whose patrons are ready to invest a



For the small sum of five cents—one nickel—six minutes' radio reproduction is afforded the patron of this automatic impresario. We suggest also a program holder.



Fig. 1  
At the left, a cross-section through the nested electrodes of the glow-tube voltage divider; it is so designed that a potential difference of 70 volts is maintained between each pair. Below, a diagram, showing how it is connected in a power-supply unit, with additional taps as needed.

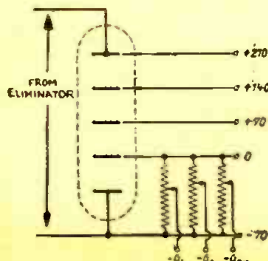



little spare change in entertainment. The capacity of the holder is six coins, and no more can be inserted at one time; all are in plain sight while in the holder. When the box is locked, the service plug is also locked in, so that it cannot be tampered with. Contacts are of the knife-switch type, suitable for breaking a light power circuit. The motor, having no brushes or contacts, does not create interference.

A feature of the coin control is that the five-cent piece travels but part of the way when first dropped; and is only released into the tray when a second coin trips the escape pin. The control might readily, of course, be used for other low-wattage electrical devices similarly operated. It is made by the Hansen Mfg. Co. of Princeton, Indiana.

**EXTERNAL TONE CONTROL**

FOR the coming season, the conspicuous feature of receivers is the tone control, which permits the owner of a 1931 model to adjust to his choice the quality of any

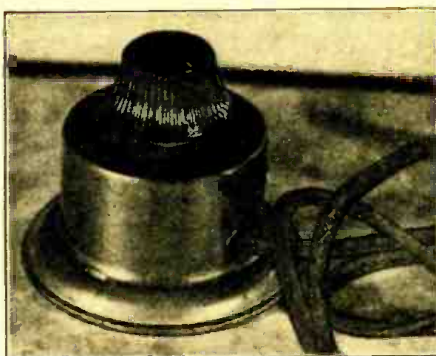

Tone control is the order of the day. This instrument may be connected to the output of any receiver which lacks that feature, and will modernize it in this respect.

reproduction, as regards its characteristics of dominant pitch; just as the volume control permits him to suit the loudness of output to the nature of the program and the size of the room (as well as the hour of the evening).

It is now equally possible to apply the

same improvement to any receiver, of whatever age, by simply connecting to it the device shown here, which comprises a resistor-condenser circuit of the kind familiar to readers of RADIO-CRAFT in experimental models, but is manufactured to supply set owners with an instrument presentable in the music room. It has a neat housing, with cushioned base to protect the console top, table or chair arm where it is most conveniently located; two long flexible leads give it mobility.

No tools are necessary for its installation; it is connected by perforated-disc lugs at the ends of the leads, across the push-pull stage, or between a single power tube and ground, by slipping the lugs over the proper pair of (grid) tube prongs, or one prong and the ground binding post of the set.

The knob above the housing, as shown in the smaller illustration, may be turned to several positions between "treble" and "bass," with corresponding changes in the timbre of the reproduced program.

(Continued on page 371)

# A "Police" Short-Wave Set for Automotive Use

WHILE a receiver in the car may be a convenience to the ordinary motorist, and even of practical value, in furnishing him with business news, modern crime detection finds it even more essential to provide liaison between headquarters and officers in the field. Radio tests have been made for some years, with transmitters and police cars; and good work has been done in Europe and Australia, as well as America; but the first standard, commercial equipment designed for this sole purpose is shown here. It is a short-wave set, especially adapted to work on the waves (between 100 and 200 meters) which have been assigned to state and city police departments by the Federal Radio Commission, and on which they send out instructions to patrolmen in motor cars and at distant posts.

This equipment, manufactured by the Delco Radio Corp., of Dayton, O., is a companion of the standard-wave automotive receiver illustrated in the August issue of RADIO-CRAFT, but differs from the latter, not only in the type of coils used, but in the fact that its tuning is not controlled from the instrument panel. Since it is used to receive transmissions only from one spe-

cial station, and must be ready to pick up a message at any instant, it is carefully set to the wavelength of the transmitter by means of screw-adjusted tuning condensers, which are then locked in position. In addition to this, while the police car or boat is in service, the transmitter will be kept turned on; it has, of course, a volume control. Its installation must necessarily incorporate an antenna and shielding similar to that used for the leads of any car; the required dry-cell batteries are housed in a shielded box, as usual.

The circuit, which is shown herewith, incorporates three '24 screen-grid tubes, which are connected in series to the car's storage battery; a first audio stage, with a '12A tube, resistance-coupled between detector and a pentode; and the latter, which serves as the output stage. This tube, which follows the description given in May RADIO-CRAFT (page 578) is here first used for the first time in a commercial receiver in America. With a filament voltage of 5, and consumption of 1/4-ampere current, it has an amplification factor of 70, and a rating of

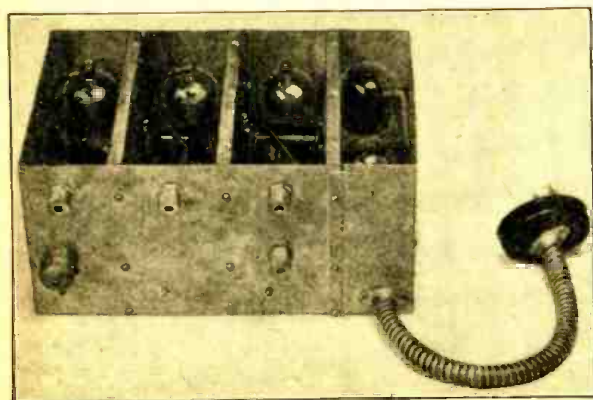
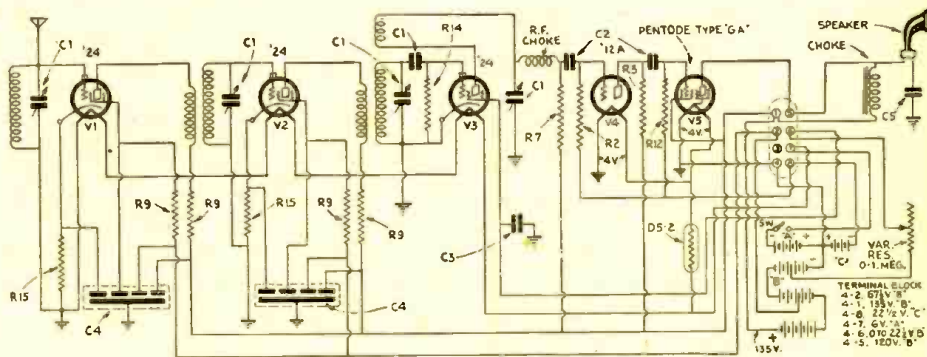

Above the schematic circuit of the Delco "Police" short-wave receiver, showing battery and speaker connections. It will be observed that a screen-grid tube is used as a regenerative detector; the variable condensers shown here are set with a screwdriver and locked (their shafts are seen protruding through the chassis in the view at the left). R2, 1 meg.; R3, 250,000 ohms; R7, 500,000; R9, 10,000; R12, 2 meg.; R14, 5 meg.; R15, 400 ohms.

500 milliwatts undistorted output, on 135-volt plate supply. It is a product of the Arcturus Radio Tube Co.

The minimum operating conditions, which permit a considerable reduction of battery voltages, are given as follows (a special analyzer being used):

	F	P	CG	SG	PC	GT
1 R.F. ....	2.0	100	1.1	55	2.0	2.8
2 R.F. ....	1.9	100	1.1	53	2.0	2.7
Det. ....	1.9	18	0.0	22.5	0.23	0.24
1 A.F. ....	4.0	80	0.1		0.13	0.5
2 A.F. ....	4.0	135	9.0	135	7.5	6.0

(F, filament voltage; P, plate voltage; CG, control-grid voltage; SG, screen-grid voltage; PC, normal plate current in analyzer; GT, grid test reading.)



# Hints to Radio Manufacturers

By Radio Users and Service Men

## A PHONOGRAPH BOOSTER STAGE

RADIO has renewed the demand for the phonograph, to a certain extent; but, with even the best needles and the highest-priced records, the volume is limited. This is felt especially when a dance is held in a school hall or a large living room.

This suggestion to the manufacturer is a call for a "Phonograph Booster," enclosed with the chassis proper, which will make an added tube available to provide a higher output level for phonograph reproduction when required.

FRANK DE MARCO,  
63 Oak St., Yonkers, N. Y.

## A CONVENIENT LEAD-IN APPLIANCE

LET me suggest that some manufacturer begin production on a temporary lead-in, for use whenever there is a temporary installation. I would suggest a small plate of copper, with a Palmstock clip, to be fastened to a window pane by small rubber suction cups. Two such plates, one on each side of the glass, would provide capacitive coupling from aerial to lead-in; and such accessories would be very valuable to Service Men.

STANLEY I. HORAH,  
Maza, South Dakota.

## A FOOLPROOF ANTENNA PLUG

THE writer has been called several times to service sets which were affected by station hum and body capacity due to a reversal of the aerial and ground leads (which many set owners prefer to disconnect during a thunderstorm, or even when cleaning); since the wires appear similar, they are often replaced incorrectly.

This could be eliminated by the provision of an aerial-and-ground cord, attached to

## WHAT PEOPLE WANT FROM THE RADIO INDUSTRY

A DOLLAR was offered, in the October issue of RADIO-CRAFT, for each practical suggestion, for the improvement of commercial radio apparatus, and suitable for publication here as a hint to radio manufacturers of what the public want. This means that we ask, not for new inventions, but for simple details, often very small ones, which make all the difference between convenience and inconvenience, satisfaction and dissatisfaction, on the part of the radio set owner and the radio Service Man.

The latter, being out in the field, where sets are used as a part of their everyday home life, not as engineering problems and samples of production, will soon see every point where the manufacturer missed a bet. Some of their proposals may be commercially impracticable; but their letters show what is wanted, and therefore what is needed.

Until further notice, each suggestion published here will be paid for at the rate of \$1.00; and their practical value, rather than their ingenuity or curiosity, will determine the selection, since this feature is intended to be of educational value to the radio industry.

a plug which could be inserted in the set only in the correct manner.

CARL W. STRAUH,  
751 Walnut Street, Royersford, Pa.

## USE A CABLE PLUG—CLOSER LOGGING

SOME all-electric receivers, with receiver chassis and power pack in separate units in one compartment, have the leads from the pack soldered to the points where they are needed in the receiver; thus making the two units inseparable. It is very difficult to lift the two together out of the cabinet, because of their weight.

Therefore, my hint to the manufacturers is that they connect the units by cable plugs and jacks, so that either can be removed from the cabinet.

My second recommendation would be that the indicators on tuning dials be made closer to the numeral strips, which will permit more accurate logging.

RUSSELL SCHREMPF,  
3656 Compton St., St. Louis, Mo.

## CHOICE OF SPEAKERS—FLAT HINGED TOPS—OPTION OF LOOP

FREQUENTLY the set owner would prefer a magnetic speaker for a change. Such a speaker, connected with the first audio stage (when the power output is very high) could be provided for in the same console with the dynamic, but on a separate shelf. A convenient switch would select one or the other.

Every console, whether for a phonograph combination or not, should open at the top to give access to the receiver, for inspection and changing tubes, etc. Moving a receiver around to get at the back often mars the cabinet and other furniture. In the average household, too, the cabinet top is normally covered by a drapery and decorations and the round top console, which will not serve

(Continued on page 370)

# The Modified "Stenode Radiostat" for General Use

SINCE the appearance of the revolutionary English receiver, the "Stenode Radiostat," described in the October issue of RADIO-CRAFT, the greatest interest has been manifested in European radio circles, and almost innumerable articles have been published, discussing the question of the reality of "sidebands." Miles of figures have been made and published on the mathematical theory; though the general agreement among the highest experts seems to be that amplitude-modulation and frequency-modulation are simply different cross-sections, as it were, of the same four-dimensional phenomenon, the radio wave. Dr. Robinson, the inventor of the Radiostat, is quoted as saying merely that "the sideband theory needs supplementing."

However, the proof of the Radiostat was that it worked; but the original model, with its carefully-guarded quartz crystal, is both expensive and complicated and, as pointed out in these columns, if the Stenode transmitting system were generally adopted, all existing radio receivers would at once become obsolete. These fundamental objec-

tions, is it understood, have now been met by the inventor, Dr. Robinson.

While the crystal-controlled Radiostat, with its 50-cycle band, theoretically makes possible a hundredfold increase of transmitting stations, it is obvious that such a development cannot take place for many years. For this reason, it is evidently more practical to use a far less selective receiver to meet present-day conditions and those of the immediate future. The present standard separation of broadcast channels in Europe is 9 kilocycles; and accordingly Dr. Robinson has designed a commercial model of his receiver, eliminating the costly crystal, and providing for a band pass of 4,500 cycles. This set has seven tubes and incorporates a 20-kilocycle intermediate frequency amplifier with a high-pass filter.

With this instrument, demonstrations have been given of reception of distant stations only 9 kilocycles removed from the high-power London stations (locals) without the slightest interference, and in an unfavorable location. Ship interference, which is troublesome in England, was also kept out

very successfully. On 4,500-cycle separation, with phonograph-modulated laboratory oscillators set up on either side of the high-power local, a slight interference whistle could be heard; though the audio quality of reception from either seemed perfect to a listener. Even this heterodyne could be eliminated with an added filter.

The Radiostat, it may be pointed out, in a seven-tube model seems little more complicated than the American standard receiver; but, in comparison with the European two- or three-tube set (the two-tube—one R.F. stage and pentode—is said to have been the most popular design at this year's radio exposition in London), it is extremely expensive and complicated. The ordinary European listener, as a rule, expects to receive only one or two locals regularly; and distant stations are a high-priced luxury.

At the present time, multiplex telegraphy experiments also are being carried out on the Radiostat system. Here a number of different frequencies are similarly imposed on a single wire line, as in practice else-

(Continued on page 368)



# An Electrical Scanning System for Television

Another Vacuum-Tube Development

By PHILO T. FARNSWORTH\*

PERHAPS the most significant element in human vision is that the amount of detail which we can see in a picture is limited by the structure of the retina. Although the image focused on the retina by the lens of the eye may be perfectly continuous, the retina will give to the image seen a finite structure, depending principally on the number of "cones" which lie in the central spot. It appears possible for the human eye to see separately at one time about 100,000 elements; this is, probably, not more than one-tenth of the number of cones in the retina. This range, however, is greatly extended by the facility with which the eyes can move from one point on an object to another; and from these considerations it was suspected that an image of perhaps 200,000 to 400,000 elements would compare favorably with that which the human eye gives us.

It will be seen from a study of standard half-tone pictures that a television image of 200,000 elements will approach near enough to the limit of the eye to make greater detail seem unnecessary.

Let us outline, then, the requirements of a television system which is to handle 200,000 elements, assuming the mode of scanning to

be that shown in Fig. 1, and that 12 pictures are to be transmitted per second. We shall have two scanning frequencies; one of them a sawtooth wave having a period of  $1/12$ th-second, and the other a similar wave of 4800 cycles per second. Our highest fundamental picture frequency will be 1200 kilocycles and, with single-sideband transmission, we shall require a wave band 1200 kilocycles wide.

### Problem of a Channel

When this work was first undertaken, it seemed quite apparent that three definite problems existed, namely: (1) a suitable scanning system to handle this high speed; (2) an amplifier capable of passing this very wide band of frequencies; (3) the perfection of a suitable wire or short-wave radio link which would take care of the wide waveband required. At the present time it is perhaps allowable to say that the first two problems have been completed.

Considerable work has been done on the development of a four-meter radio link. The progress to date indicates that quite satisfactory television service could be had for distances up to about fifty miles by proper location of the transmitter. Trouble from double images and fading may not, after all,

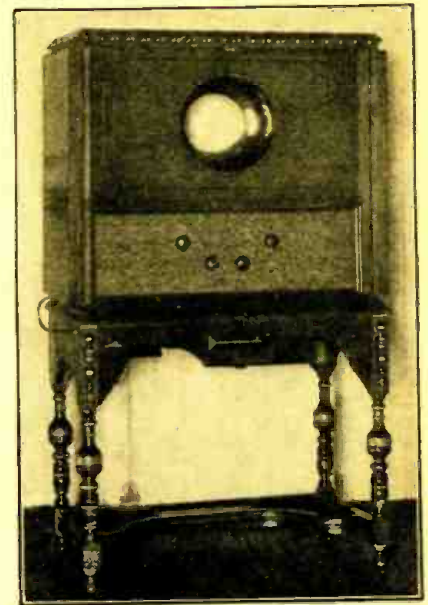

Fig. C

A television receiver, using the "oscillite."

cause particularly serious trouble. Absorption by conductive obstacles will make it necessary, however, to locate the transmitter so that it will be almost visible from any part of the area it is to serve.

Considerably more success has been obtained by the use of wired radio as a medium. It has been found quite practical to modulate a 300-kilocycle band upon a 1000-kilocycle carrier, and to transmit this over an ordinary telephone line; the pictures so transmitted are practically equivalent to those seen on a monitoring set located close by the transmitter. The attenuation in voltage has been found to be about 45 decibels per mile for a No. 19 pair cable. It would probably be necessary to relay every few miles with this attenuation; but it is thought that a cable line represents the extreme case and that, when an open wire line is used, television by means of wired radio becomes entirely within the range of possibility.

In our experiments so far, no attempt has been made to correct the line for phase shift and frequency discrimination; this may not be necessary, but it is thought that considerable improvement in the transmitted image might be attained by carefully making these corrections.

Synchronization is accomplished simply by putting the synchronizing frequencies on the same telephone wire; audio frequencies may, of course, be put on the same pair.

### The "Dissector" Tube

The first-mentioned requirement, which will be the subject of this article, has been solved by the development of an electrical scanning system. The basis of this is an "image dissector" tube, a practical form of which is shown diagrammatically in Fig. 2 and in cross-section in Fig. 6A. As will be seen, it comprises a cathode (C), coated with photo-sensitive material, which is parallel and closely situated to an anode screen (A). The anode screen is electrically connected to the electrostatic shield (S). At the end of the tube opposite the cathode is placed a target electrode (T) having all but a single small area shielded from the discharge.

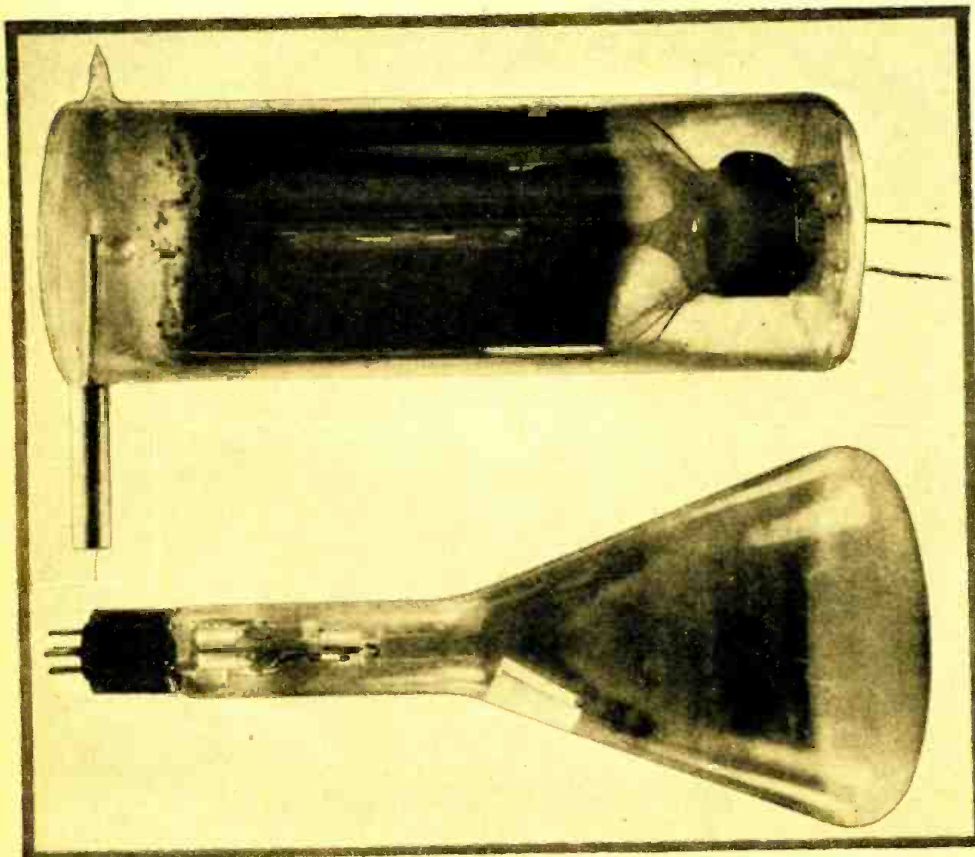

Fig. A (above)

The "dissector tube," with its "target" shown at the left, is used for transmitting.

Fig. B (below)

The "oscillite," or receiving tube; the image appears on the flat surface at the end of the bulb.

\* Television Laboratories, Inc.



This tube, considered broadly, is a photoelectric cell wherein provision is made for forming an "electron image" of an optical image focused on its cathode surface. By "electron image" it is meant that, if a fluorescent screen were placed in the plane of the electron image, the original optical image would be reproduced. The condition necessary for the formation of this electron image is that all the electrons emitted from any single point on the cathode surface shall meet again in a corresponding point in the plane of the electron image.

An image of the object to be transmitted is focused upon the cathode, and the photoelectrons emitted therefrom are accelerated by a potential of the order of 500 volts between the cathode and anode screen. Most of them are projected into the region between the screen and target and, by means to be described later, combine to give an electron image in the plane of the target. This electron image, made up as it is of a prism of moving electrons, can be shifted by a magnetic field at right angles to the tube. By this means, the image is moved over the scanning aperture in the target shield.

In practice, two sets of coils are placed about the dissector tube, as shown in Fig. 2, at right angles to one another. A sawtooth-wave alternating current, of about 3000 cycles per second, flows through one set of coils; producing, let us say, a horizontal deflection of the image. A current of similar waveform, but with a period of 1/16-second, flows through the other set of coils, and produces a vertical deflection of the image. The resultant path of the image, relative to the aperture, is similar to that given in Fig. 1; there will be 200 horizontal lines drawn for each traversal of the image, and the time of one line will be 1/3000-second. We shall therefore require an amplifier handling a band width of approximately 300 kilocycles, to amplify the target current.

It has long been apparent that the full development of television requires a scanning device free from the mechanical limitations which are inherent in the motor-driven disc or drum. With the latter, four or five thousand points are all that we can expect in an image; and these can show clearly little more than a single person in a limited field.

The electron tube, with its "weightless beam," has been an obvious solution; but the task of making it effective is one requiring no small degree of ingenuity and application to detail. Mr. Farnsworth, in his laboratory in San Francisco, has been working for some years along this line; and it has been known for some time that he has obtained striking results. Until now, however, no detailed statement of his methods has been available.

In this article he explains for the first time the operation of his "dissector" tube, a photoelectric device used for scanning at the transmitter; as well as his experiences with the "oscillite," an oscillograph which he has improved for the purpose of reproduction. He has constructed also a special amplifier, having a favorable characteristic over a frequency band 600 kilocycles wide, details of which he encourages us to expect soon.

Mr. Farnsworth sets the maximum television image required at 200,000 points—eighty-seven times as extensive in detail as present standard-disc scanning—and for this work he states that a 1200-kilocycle channel will be required. He has already transmitted 300-kilocycle signals by wire and by radio on a wavelength of four meters.

We know that all television enthusiasts will hail this substantial contribution to the perfection of the art.

This problem presented by the amplifier has been one of the most difficult encountered in any of this work. Furthermore, at the higher frequencies, the impedance in series with the dissector target becomes very low, because of the capacitance shunting it; and this causes a corresponding decrease in the amount of voltage delivered to the input of the amplifier. However, the whole problem has been greatly simplified by a system of "admittance neutralization," which is particularly useful in the neutralization of capacity, and which permits input impedance (as well as interstage tube impedance) as high as several megohms to be obtained, up to a million cycles or more. At the present time an amplifier is being used which has a frequency-characteristic approximately flat to 600 kilocycles. The "admittance neutralization" principle, as well as the design

in general of these wide-frequency-band amplifiers, will be explained at another time.

#### "Oscillite" or Receiver Tube

The picture frequencies from the amplifier are re-built into an optical image at the receiver by means of an electron-beam tube, or "oscillite," as shown in Fig. 3. This is simply a modified Braun oscillograph, which makes use of the electron-image principle of the dissector tube, to allow good light intensity to be obtained.

It is required to generate at the receiver, two alternating currents of sawtooth waveform, identical to those used at the transmitter. These currents, of course, have to be synchronized with those at the transmitter; to accomplish this, use is made of the fact that these currents induce a strong voltage pulse in neighboring circuits during

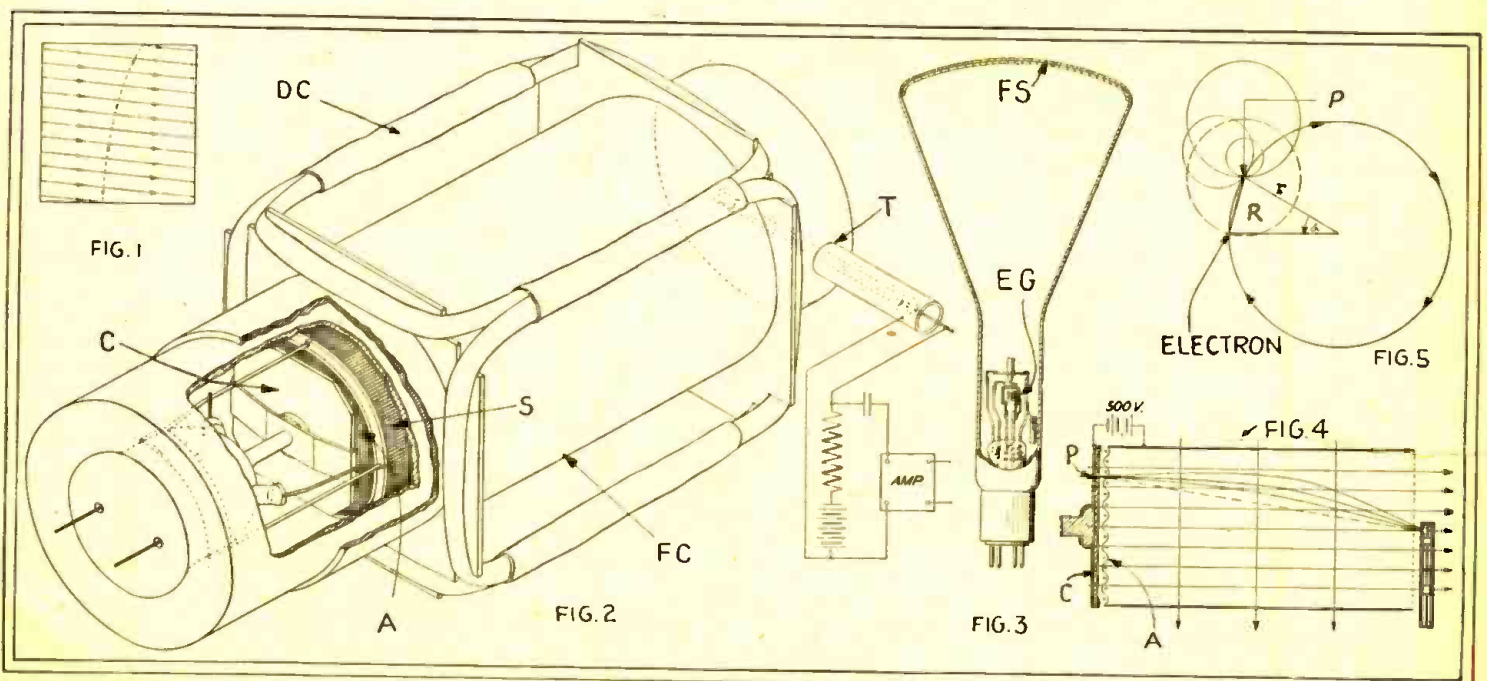

The magnetic scanning at the upper left assumes its shape as a resultant of two moving fields. The "dissector" of Fig. A is shown here internally in Fig. 2; and the "oscillite" of Fig. B in cross-section in Fig. 3. Fig. 4 illustrates the path of electrons from an illuminated point on the cathode; and Fig. 5 is an end-on view of their rotating motion. The object is to bring them all to the same point at the target.



the steep part of their slope. This voltage pulse is, accordingly, introduced into the picture frequencies' circuit, and serves at the receiver to hold the scanning generators in step. It serves the further purpose of turning off the oscillite "spot" during the return part of its path; that is, during the very steep part of the sawtooth wave-cycle.

This system of synchronization is very simple and very effective. It does not require any extra transmission medium for the synchronizing impulses, nor even any extra equipment such as filters, etc., to separate the synchronizing impulses from the picture frequencies. Much work has been done in the development of these sawtooth-wave generators, and on this system of synchronization, but space requirements will not allow their being reported here.

"Magnetic Focusing"

Consider the path of the electrons which leave the same point, on the surface of the cathode, at which a point of light in the optical image is focused. If all of them traveled parallel to each other, a perfect image would be formed at any point of the beam. But they are emitted at different velocities, corresponding to potentials from zero to about three volts. The irregularity of the cathode's surface, large in proportion to the electrons, and the ending of electrostatic lines of force near the wires of the anode screen (A) cause the electrons to spread out in a conical ray—with an angle at the apex of about five degrees, in our present dissector tubes. Nevertheless, something of an image may be formed at the window by the use of low-frequency (red-dish or infra-red, presumably, to which photoelectric surfaces are less sensitive—Editor) light, careful construction of the anode screen, and high anode voltage. However, it has been found possible to focus these electrons rays magnetically.

This is done by creating a uniform magnetic field of proper intensity, with lines of force parallel to the axis of the tube. This causes the electrons to follow spiral paths, all tangent to the line of magnetic force through the point P where they originate. Each electron, viewed from directly ahead, is describing a circle, large or small, as it travels forward. (See Fig. 5.) However, regardless of the speed of the electron, and the diameter of the circle, it will reach the same point on the circle, from which it started, in the same time; that is, every electron will be in line with P at a given time. This makes it possible to bring the whole beam of electrons to a point on the target, as shown in cross-section in Fig. 4.

If we change the direction of the field, the point where the electron beam is focused will be shifted; and, by imposing a transverse magnetic beam on the lengthwise field, we will deflect the electrons proportionately. In this manner the deflecting coils, carrying alternating currents, will cause the beam to move from side to side.

The present dissector tube with its carefully-made anode screen produces a stationary electron image which is not inferior to a very good optical image. When the image is deflected for scanning, however, the resulting moving image is slightly blurred at the edges, for the following reasons:

The distance from the cathode is slightly greater than at the center;

The velocity of the electrons toward the aperture is less for the edges than for the center.

The magnetic field, in the direction of the electron's path, increases with the angle from the center.

All these factors are reduced by increasing the deflection distance. In practice, 15 degrees deflection on each side of zero is the value used, when the scanning aperture is not smaller than 15/1000-inch.

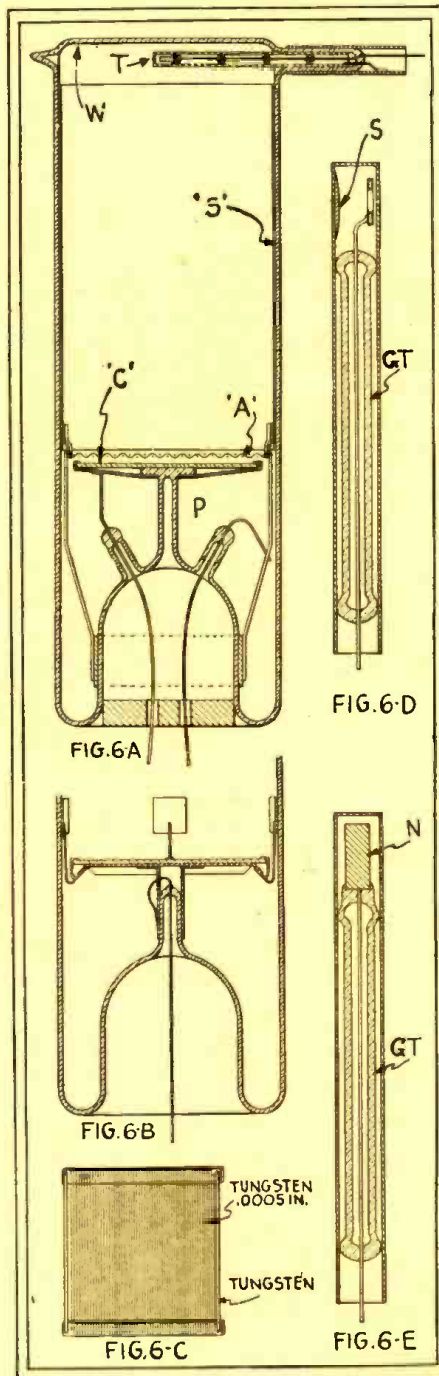

Left, cross-sections of two "dissector" tubes, and (at 6-C) the anode. The cathode C throws out from each point a ray of strength proportionate to the light received. The electrons pass the anode A and fall on the target T; as they scan this, it transmits each element of the image to the amplifier. D and E are cross sections of target rods; N is a nickel target, and S a fluorescent substance while GT is the glass tube.

The principle of magnetic focusing becomes very useful in the construction of oscillite or receiving tubes. It enables us to focus back, to a point, all electrons from a single emitting point; and thereby to obtain very good light intensity in one of these tubes. In fact, the light intensity so obtainable is limited only by the properties of the fluorescent material. Spot intensities can be obtained which turn fluorescent material black and inactive after only a few seconds' exposure. The element used in this work will be described later on.

The reproduced photographs here were taken from the receiving tube, from transmitted motion-picture film. The large image (of Dr. Lee de Forest) was secured by making the film from a still photograph. The exposure was about half a minute, and the blurring is due principally to the fact that the picture on the receiving tube moves slightly. The effect is quite negligible to the eye, but gives a badly-blurred image when exposed so long to the camera. It is shown merely to represent the inferior limit of quality. (Fig. D.)

The smaller images at the side were made with 60-cycle scanning current, and moving the film at both the receiver and the transmitter at approximately the same rate of speed—about one frame every two seconds. They therefore indicate the quality of dissection, but not the perfection of the amplifier.

The actual image, as it is seen on the receiving tube, appears much better than any of these reproductions; as those who have seen it will attest.

Types of Dissectors

The high-vacuum dissector tube (see Fig. 6A) in use at present comprises a cylindrical glass envelope, having at one end a flat window (W) which is polished before sealing in. At the other end is a stem, upon which the elements of a tube are supported and through which the leads pass. The inner end of the stem carries a short glass pillar (P) terminating in a square button; the button supports a silvered mirror on which is deposited a photo-sensitive film. A hand clamp is supported from the stem, having welded to it wires which carry the anode structure.

The anode structure itself (see Fig. 6C) is made by winding very fine tungsten wire around a tungsten-nickel frame as shown. This is supported from the collar, so that it is closely parallel to the cathode. Supported separately from the collar is a cylindrical screen, usually of fine nickel mesh, which conforms closely to the inner surface of the glass envelope. (In the latest types of tubes, this screen has been replaced by a platinum coating on the walls of the tube.)

Two general types of targets are in use; that shown in Fig. 6D is designed to make use of secondary emission; while that shown in Fig. 6E is intended only for primary emission.

Photoelectric Substances Used

After the elements of the tube have been sealed in, it is sealed to the pump in much the same manner as an ordinary photoelectric cell, provision being made to distill into the tube a small amount of potassium.



After the tube has been baked for three or four hours on the pump, and the vacuum is as good as can be obtained, a small amount of potassium is distilled into the tube and allowed to condense where it will. Then, by heating the lower portion of the tube, the potassium is deposited upon the cathode; the tube having been designed so that the cathode remains cool, unless the stem is heated.

It is necessary to be very careful in this process, to drive the potassium very slowly. Otherwise there is produced a glazed cathode surface which has been found to be inferior in uniformity to an unglazed surface. Care must also be taken to keep the target of the tube warm during the potassium distillation, to insure that no metal condenses inside the target shield.

After the tube has cooled thoroughly, hydrogen is admitted and the surface colored by the Elster-Geitel process. Care

equal reflecting power, at a distance of one foot with a 1500-watt tungsten lamp. This sensitivity, therefore, approaches the order of that required for direct scanning.

Zworykin (see RADIO-CRAFT for February, 1930) reports sensitivities of 25 microamps./lumen; this sensitivity would permit direct scanning with lamps that are not too bright to be used with animate subjects. Dissectors of this sensitivity, however, have not been built as yet.

Dissector tubes may be built to operate without an anode screen. Fig. 6B shows the construction of such a tube. Its principal advantage is its simplicity; it has the disadvantage of giving a rather poor electron image, and has not thus far been built with a ratio, of aperture to cathode area, greater than one to five thousand.

#### Receiving System

The receiving system used in connection with the dissector tube is closely similar to

effect is not bothersome at all; in fact, it is necessary to have very high current density, in order to observe it.

The deflection-coil system used with the oscillite tube is exactly similar to that used with the dissector tube; the power required in these coils for the largest possible pictures may be generated with a '10 tube, while that for the focusing coil is quite negligible. One type of scanning generator used at the receiver embodies a helium glow-tube feeding a '10 power tube.

The circuit required to get the requisite amount of power from a '10 tube into an entirely inductive load has been developed over a period of several years; the details will not be given here.

These generators are synchronized by coupling them with the main picture-frequency circuit since, as explained before, the requisite pulses are induced at the transmitter.

The writer wishes to acknowledge his indebtedness for valuable assistance received during the progress of this work, to Mr. Donald K. Lippincott, particularly for his assistance in working out the principles of magnetic focusing, but also for the constructive interest he has shown during the entire course of development; to Mr. Carl J. Christenson, for many valuable ideas contributed during the early stages of the work, and to the staff of Television Laboratories for their unstinted co-operation.

Fig. D

The image of Dr. Lee de Forest (center) though blurred is recognizable; this is a composite of the images reproduced on an "oscillite" for half a minute. The smaller images at either side had shorter exposures.



must be taken at this stage to insure the exact pressure of hydrogen which will permit the entire surface to form at one time; otherwise a non-uniform emitting surface will result. The cell is then carefully pumped to rid it of all traces of hydrogen; after which it is sealed off the pump.

The work of A. R. Olpin and L. R. Koller has indicated two general methods for greatly increasing the sensitivity of photoelectric cathodes; the Olpin process particularly has been applied with great success to the construction of dissector tubes. The general technique, as it has been evolved for the preparation of these "sodium-sulphur" dissector cathodes, is closely similar to that employed by Olpin. One rather interesting side light is that if, in the preparation of the sodium-sulphur cathode, it is spoiled for some reason or other, a moderately sensitive dissector is secured simply by admitting hydrogen and passing a glow discharge, as in the Elster-Geitel process. This usually gives a cell with a sensitivity of one microampere per lumen (unit of illumination) and the sensitivity seems to be more permanent than with the potassium-hydride cell.

The sensitivity of such a dissector, like that of the usual potassium-hydride photo-cell, is best at about one-half microamp./lumen (or one-twentieth that of a gas-filled photo-cell) though this can be nearly doubled by the use of secondary emission from the target. The potassium-hydride cell is, therefore, not sensitive enough to be used with light reflected by an image; the present cells are used with transparencies and a 400-watt tungsten lamp.

The sodium-sulphur cathode dissectors have a sensitivity of 6.5 microamps./lumen; a suitable light intensity may be obtained by illuminating the face, or an object of

that proposed by Nielsen and Rosing, and to that recently demonstrated by Zworykin. The oscillite tube differs from Zworykin's "kinescope" in the means used for focusing the spot and in the detail of the "electron-gun" element.

The magnetic focusing principle, as stated before, permits all electrons having a source in the same point to be focused back to a point on the fluorescent screen. The electron-gun element has been designed with the idea of securing the greatest possible number of electrons through a given-sized aperture, and limiting the angle of this beam to that which can be accurately focused. This element (as shown in Fig. 3) comprises a spiral filament coated only on the inside. A shield, perforated by a hole of the same diameter as the filament helix, is placed over this filament. The anode is tubular in form, and placed in front of the cathode; while a ring grid is placed about midway between the filament shield and the anode.

The merit of this type of element lies in the fact that the anode tube is located, approximately, at the focal point for the electrons leaving the emitter. The anode voltage, required to create this focal point at the entrance to the anode tube, may be of any value between 1500 and 2500, for the tubes we are using at present.

An interesting effect has been noted with regard to the operation of these tubes; they function only when secondary electrons are emitted from the fluorescent screen. Sometimes a black spot will appear on the end of the tube, due to that point's charging up negatively. It will be recognized that an unstable condition exists here, and that a point on the fluorescent screen will assume either a large negative or a large positive potential with respect to the anode. This

## News of Television

THE first international television convention, it is announced, will be held in Brussels, Belgium, in July, 1931. It is not an official affair, like the radiotelegraph conferences, but called by a private association, the International Institute for Television, which has its headquarters in the Belgian capital.

The first television museum is being prepared by the Deutsche Museum of Munich, Germany, which will endeavor to present an arrangement of all systems of television which have been practically operated.

On July 28, a demonstration of full-size television was given at the Coliseum in London, utilizing the Baird system. The screen, 32 inches wide and six feet high, contained 2,100 incandescent lamps, which were lit in turn through an elaborate commutator.

Engineers of several large American broadcasting companies appeared before the Federal Radio Commission on October 3 to present television problems. "Reliable reception of satisfactory pictures," said M. A. Turner, of the R.C.A.-Victor Corporation, "will be a very local proposition. This fact would indicate that the central section would best be served by a centrally-located transmitter. The area which this transmitter would be able to serve would have to be determined by actually receiving pictures at different points within the area."

Special tests were recently conducted, at the request of the Federal Radio Commission, to determine what interference, if any, is caused by the television stations which broadcast on the same wavelength simultaneously. Some rearrangement of wavelengths has recently been made; and the

(Continued on page 375)



# Actual Television Now Taught in School

*A Practical Radio Education Must Now Include Instruction in the Technically Most Important New Development of the Art.*

By HAROLD C. LEWIS\*

I AM fully aware of the fact that there are in the radio industry today many people who maintain that television is so far in the future that it is of no practical account at the present time.

I am aware of the fact that some of the larger radio interests are forcibly holding television down, because they do not wish to have a repetition of the growth of the radio parts business when the broadcast boom started in 1922. These interests wish to jump into the market with a complete set and, for that reason, do not encourage television.

The facts in the case, however, are that in the United States and, particularly, in Europe, television has already arrived and may be placed in the same stage where radio was in 1920. I admit that television has not gone over big with the public as yet; but it certainly has gone far enough when, at this moment, in the United States alone, there are already over 25,000 television sets which are "looking in" almost every day on some kind of a television broadcast. In all evolution, we must creep before we walk. In radio, we had the crystal detector and the earphones and we had instruments scattered all over the table, but we had a lot of fun at it. The complete set did not come along until some time in 1925. Television will run a similar course.



H. C. Lewis

I have had sufficient confidence in the future of television to expend a sum in excess of \$25,000 to provide actual television apparatus in my school, where students are actually taught the principles of television. To my knowledge, it is now the first and only school that is in a position to do so.

When students have satisfactorily com-

pleted the preliminary theoretical courses, they become qualified to continue in the new department for those who want to be equipped with a practical knowledge of television. They are instructed in the assembly and operation of televisors for reproduction of television images, and they also receive instruction on the types of short-wave receivers now in use for the reception of television impulses, or energy used to operate these televisors. The operating principles of the latest types of television transmitters and receivers are thoroughly covered, and students receive also actual operating instructions on television transmitting equipment of the type used for programs, with live subjects or artists, and also on film-scanning machines for sending out motion-picture entertainments by television.

## Special Instruction in Television Required

An ability to readily detect the causes of distorted, imperfect pictures (perhaps marred by streaks of light or dark, shifting views, "ghost" images, reversed figures, and other phenomena peculiar only to television) and to as readily remedy these faults, is becoming of greater value daily. At the present time, there are estimated to be well over 25,000 television receivers in operation. Projected plans reveal that, in a fairly short time, this number will be increased a great many times. As in the case of code and broadcast radio, the technician who is prepared with knowledge of this rapidly developing branch of the art will be most in demand.

As just stated, the causes and remedies of television troubles are numerous. More important still, they are not comparable with radio conditions as the radio broadcast receiver Service Man knows them. Their symptoms, ailments, and cure, are entirely divorced from ordinary service work.

For instance, the radio "music" receiver pronounced "perfect" in audio quality in this reproduction of music may be (and probably would be) totally inadequate if employed for television signal amplification; the result being as bad, or worse, from a pictorial standpoint, as the reproduction was, from an audio standpoint, of a radio set of the vintage of 1921. Perfect reproduction up to 10,000 cycles will result in beautiful musical output; but, unless the amplifier continues at this efficiency up through 30,000 to 50,000 cycles, its use as a television adjunct will result in loss of "detail." The methods used to obtain a good amplifier for television work are quite a study.

Another outstanding consideration in television instruction is the correct installation of transmitter and receiver apparatus. Television equipment, in its installation tech-



Students setting up the scanning apparatus of a television transmitter. The model shown televises the features of a direct-lighted human subject.

\* President, Coyne Electrical School.



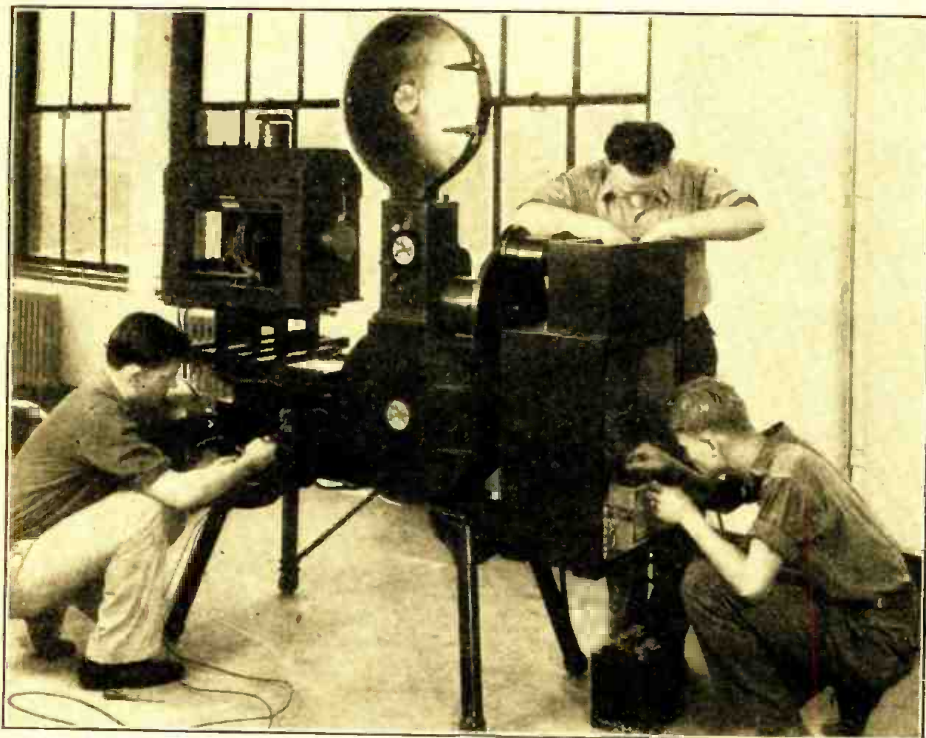

Another transmitter in the Coyne television department. This scans and televises motion-picture film for the well-known "radio movies."

nique, is just as much a matter of specialization as the installation of "sound movies." An example of this was given a short time ago when one organization found, after installing its picture transmitter, and announcing its date and time of transmission, that its location was useless for picture work; even though it was an excellent one when judged by the standards for ordinary, musical radio reproduction.

However, like the fundamentals of radio voice reproduction, which have remained almost unchanged, the basic principles governing picture transmission and reception will not undergo any very great changes in the years to come. It is easier to learn these principles now, and modify them as time dictates, than to face these plus their ramifications at a later date. A knowledge of the photoelectric cell, the scanning disc and the neon lamp will be fascinating and profitable.

All this has been done in order that each student may receive practical instruction on actual equipment in this great new field. Thus, they will obtain a thorough understanding of this equipment up to its very latest stages of development, and be well equipped to get in on the ground floor in the opportunities now opening up in this interesting new branch of radio.

## A New Synchronizer for a Television Receiver

By C. H. W. NASON

IT is well known to radio experimenters that, where both the transmitter and receiver are fed from the same A.C. supply, television scanning members may be synchronized by the use of standard synchronous motors with the same speed of rotation. Where it is necessary to receive signals from distant transmitters, which do not take their current from the same power network, these synchronous motors are worse than useless.

For instance, if the frequency of the line supply at transmitter A is 60.00001 cycles, and that at the receiver B is 60.00002 cycles, the picture will drift slowly across the frame; and the objective of synchronous, or completely "in-step," picture reception, will not be achieved, even though the transmitter and receiver have been "phased" as far as possible by the use of synchronous motors.

### The Characteristic Frequency

There is a property of the television signal which enables us to find simple solutions to the problem; all who have listened to it in the loud speaker have noted a characteristic tone. This tone has a frequency dependent upon the number of images each second and the number of lines scanned per frame. Thus a 48-line picture repeated 15 times per second—by using a 900 r.p.m. motor—has a characteristic frequency of 720 cycles per second.

It would appear quite simple to construct an amplifier capable of delivering many watts of energy to a 720-cycle motor,

and operate our scanning disc from this source. Regardless of the seeming simplicity, not all of us are in a position to operate amplifiers with an output of 250 watts or more, and consequently we must effect a simplification.

This has been done, both experimentally and commercially, by the simple expedient of employing two motors. One of these, which provides the necessary energy to rotate the disc and overcome frictional losses, may be a "universal" or a variable-speed motor of any type available. The other, which operates from the amplified signal and serves to maintain the correct speed, is usually a diminutive *synchronous motor* of the "phonic-wheel" type. It is a fact, however, that devices of this nature suffer from the effects of *line-voltage variation* and are rather difficult to bring into synchronism.

### A Synchronizing Amplifier

The writer has investigated a system, not entirely dissimilar, but having many marked advantages over the methods just described.

If you will refer to Fig. 1 you will see at first an audio or "synchronizing amplifier," employing resonant parallel feed and having in its output a small alternator A which generates a current alternating at 720 cycles per second when it revolves at 900 r.p.m. The alternator (or generator) and the driving motor are mechanically coupled by the same shaft to which the disc is affixed, as shown underneath. Further investigation of the diagram will show that the push-pull output stage has an "A" supply only—no "B" or "C" potential being applied to the tubes.

(Continued on page 362)

Fig. 1  
With this apparatus, described by Mr. Nason, it is not necessary to use vacuum tubes of sufficient power to drive the scanning disc, as in some synchronizing systems. Only sufficient output is necessary to exert a slight braking influence. The motor B is set to run very slightly fast; and the load placed on the shaft by the current drawn through A is sufficient to hold the disc down to the synchronizing frequency (here 720 cycles) of the television signal, which is especially amplified by the two 71As, V2 and V3.

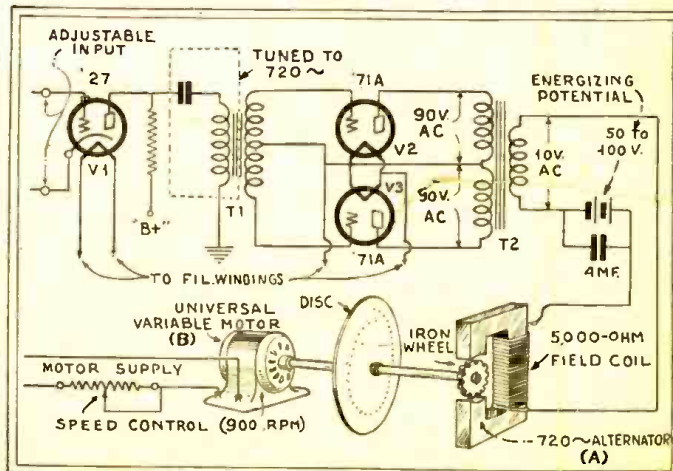



# SHORT WAVE CRAFT

## The "Superband" Converter for Short Waves

By PIERRE J. NOIZEUX (Buenos Aires)

**A** VERY desirable means of obtaining short-wave reception is to utilize the present broadcast receiver as a superheterodyne, by means of a short-wave converter. It is unnecessary to change any of the internal connections of the receiver, which is used solely as an intermediate-frequency (and A.F.) amplifier. The idea is not new, and many converter circuits have been published.

For several reasons, we prefer the "Superband" circuit, shown in Fig. 1, which assures the greatest independence between the first detector and the oscillator; each of which can be tuned without affecting the other. The output of this converter may be connected directly to the antenna post of any receiver, without danger of a short circuit.

In operation, one first adjusts the broadcast receiver to a point where no stations are heard on the broadcast band. As no receiver is equally sensitive on all wavelengths (most of them are most responsive at the higher frequencies), it is desirable to seek a setting near the point of highest amplification. If the receiver has several tuning controls, adjust them all for the greatest sensitivity.

Then connect the aerial lead-in directly to the input of the first detector; turn the dial of the detector to any position, and rotate the oscillator dial in search of a signal. If none is heard, reset the detector

dial a few degrees, and search again. When a signal is tuned in, adjust the dial of the first detector to obtain the loudest signal, and set the potentiometer for greatest sensitivity. If the broadcast receiver is of the single-control type, its setting may be adjusted, instead of the oscillator dial.

The lead-in clip is then connected to the antenna coil L. Begin at the middle of the coil, and gradually move the clip toward the ground terminal; testing each connection until the greatest signal intensity is found. When this operation is completed, it may be well to reduce the volume control; for many short-wave signals will be found too loud.

For greatest convenience in operating this converter, the condensers tuning the R.F. and the first-detector stages may be ganged on one shaft, using midget condensers to trim them.

### Values of Parts Used

The coils used by the writer were made as follows: L and L1, each five turns of No. 4 copper wire, spaced 1/5-inch apart, self-supporting and 2 inches in diameter. Equivalent coils may be used for a .00025-mf. condenser, or whatever value is employed.

The oscillator coil has two windings (as shown in Fig. 2) of six turns each on a two-inch tube, of No. 22 wire, spaced 1/5-inch. These values are suitable for reception between 17 and 40 meters.

**I** NTEREST in short-wave reception is international, and particularly so in the southern continents, where the only possibility of hearing broadcasts from Europe and the United States is on the short waves.

This converter, designed by a South American engineer, uses three tubes to produce a heterodyned signal, which is fed into an A.C. electric broadcast set, and, thereby, specially high amplification of the signal is obtained. With such a combination, an automatic volume control of the type we have described elsewhere would be valuable.

The coupling between the '24 first detector tube and the '27 oscillator is different from that usually employed, and isolates the two tuned circuits from interlocking. While it puts but a small part of the energy of the oscillator on the first detector, it will be remembered that an oscillator is much more powerful than the received signal.

We think that many short-wave fans will be interested in this novel hook-up.

The 5000-ohm resistor R1 (which may be of the variable type) is used to reduce the voltage applied to the plate of the oscillator and prevent unnecessary current consumption.

The 100,000-potentiometer R2, which regulates the screen-grid voltage, may be set, to begin, at the third of its resistance, to apply a potential of 50 volts or so.

It is necessary to shield the stages very carefully from each other, to prevent coupling. A separate can is used for each.

The converter may be used without the R.F. stage shown here, in which case the lead-in clip is attached directly to the turns of L1 instead of L.

It is preferable to use a small "B" power unit, separate from that already employed with the broadcast receiver; nevertheless, leads may be taken from the latter, with suitable precautions against coupling. (Filter chokes or resistors, with suitable by-passing.)

The quality of reception obtained by the use of this converter is excellent, and the modulation of short-wave broadcasts will be found as good as that of the local broadcasters. The cost of parts is small and the assembly is not difficult; so that the construction of this converter may be recommended to anyone who has a good broadcast receiver, and wishes to listen to short-wave broadcasting under the best conditions.

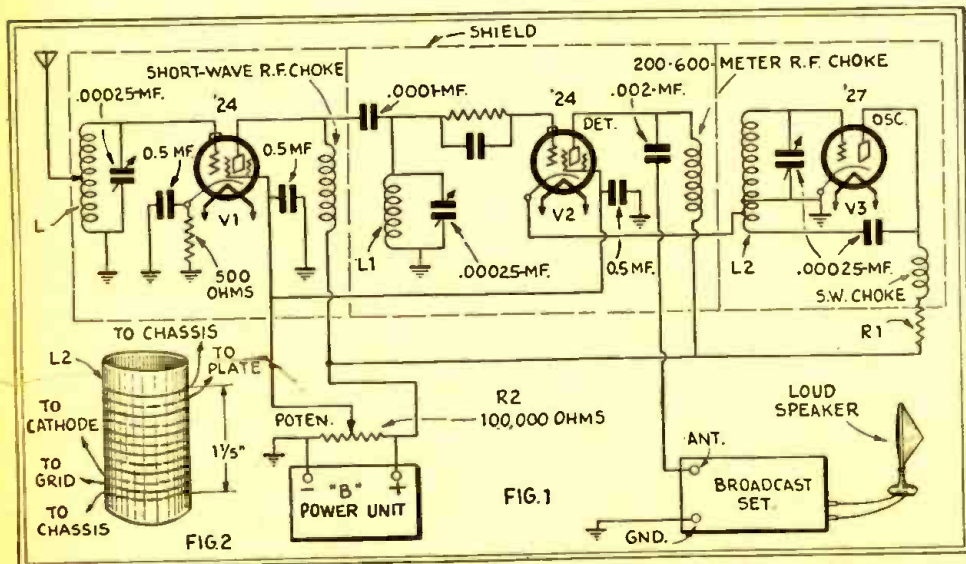

This converter design, though it comes from South America, uses tube types familiar to us. As constructed, it covers but one band, that giving greatest distance; and constructors may prefer plug-in coils and an aerial coupling condenser, for greater convenience and versatility. The illustrations, adapted from Revista Telegrafica, show an R.F. stage which may be omitted.



# With the Short-Wave Experimenters

## A STABLE S.-W. RECEIVER.

Editor, RADIO-CRAFT:

I enclose the circuit of my short-wave receiver, which has the advantage of avoiding changes of volume on long-distance reception, and is extremely stable in operation. Reception is obtained from 20 to 50 meters with two coils. The set is of course well insulated, with a double panel, inside of which is a cabinet well shellacked to withstand dampness. Only 90 volts of "B" and  $4\frac{1}{2}$  of "C" batteries are required; and when a station is tuned in, you may enjoy the program without adjusting any further controls. An air-column speaker is best with this set.

The secondary coils are  $3\frac{1}{4}$  inches in diameter, and wound of No. 10 copper wire, spaced  $1/5$ -inch. The 20-35-meter coil has 4 turns, the 35-50-meter coil 8.

The ticklers are placed inside the secondaries; they are wound closely with No. 30 wire. The shorter-wave coil has three turns, the longer 4. These windings are placed at the same end as the primary, which is eight to ten turns of No. 22 wire, close-wound.

The tuning condenser is a 7-plate Pilot, the regeneration condenser an 11-plate. The grid condenser is .00025-mf.; and the grid leak of 4 megohms is connected, as shown, to the arm of a potentiometer, for the purpose of regulating the grid current and avoiding detector distortion, at the same

time that volume is increased. The detector rheostat is 30 ohms, the other 20. Care must be taken to match the push-pull tubes; which are used with a Pilot push-pull impedance coupler.

The R.F. choke, to which I attribute the  
(Continued on page 372)

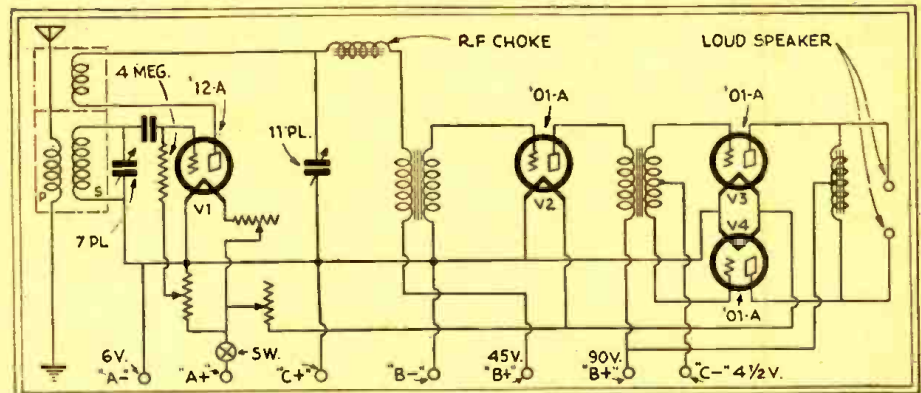

Fig. 1

This receiver, whose constants are described in the text, uses a special iron-core choke in the plate circuit. In other respects, it is not unusual, except for the potentiometer control and push-pull 01As.

## Selecting the Intermediate Frequency for the Short-Wave Superheterodyne

By L. W. HATRY

IN the October, 1930, issue of RADIO-CRAFT the writer discussed the design of the short-wave superheterodyne: considering the type of oscillator circuit; the signal input, first detector, and second detector connections; the tuning coils; and a number of other considerations peculiar to effective short-wave receiver design.

In the November issue various possible arrangements for obtaining most satisfactory operation, at the intermediate frequency selected, were described.

This month the difficulties, in determining just what that intermediate frequency should be, are brought to light; as a result of long hours spent in the laboratories of the writer.

There is probably no single point in "super" construction that has caused more comment than the "repeat point" (erroneously termed a "harmonic"); and it is this factor in the short-wave receiver design that will next be analyzed.

### "Repeat Point" on the Dial

There are three principal elements bringing about this condition. These are: (a) first-detector tuning; (b) oscillator tuning; and, (c) intermediate-amplifier tuning.

The I.F. tuning in most double-detector (superheterodyne) receivers is fixed; because one predetermined frequency is chosen and used. The detector tuning is adjusted to the signal frequency (that is, to the wave of whatever station is wanted) and the oscillator frequency is tuned to differ from the signal frequency by the value of the intermediate frequency; which means that when, for example, the I.F. is 300 kc. the oscillator tuning will be 300 kc. either above

or below the signal frequency. Thus the oscillator tuning dial may be capable of showing at least two tuning points for any one of the detector's. If both detector and oscillator dials, as a result of the circuit design, give the same dial-number for, say, WEA-F, then WEA-F's second tuning point on the oscillator may be found by adjusting the oscillator dial alone.

This "repeat point" is normal and must exist; it is sometimes wrongly called a harmonic. Additional repeat points found for one station are caused, except in rare cases, by the oscillator harmonics; that is by frequencies double and treble the oscillator's fundamental. And each of these harmonics (that is, the second and third), like the fundamental, will have two equally good tuning points on the oscillator dial! It has been said that the detector tuning should not show a repeat point for any station; and this is true so far as the receiver is concerned. If, however, the station radiates a complex frequency (fundamental and harmonics) the detector might tune in a harmonic too, and thus show a repeat setting which is not the fault of the receiver. Crystal control, however, has practically eliminated such faulty broadcasting today.

Keep the above repetition of tuning divisions clearly in mind when reading what follows (if you are still with us).

If effective selectivity is but slightly aided by the detector's tuned circuit, when we deal with a strong signal, it is important that we obtain from this circuit its maximum effect to keep out nearby stations. On medium or weak signals a single tuned input circuit is very effective, because of the se-

lectivity resulting from the cascaded tuned circuits of the I.F. amplifier, and the heterodyne method of obtaining the I.F. through the use of the oscillator.

The more successful and later models of the standard superheterodyne, used for reception of broadcast stations, for the reasons given, now comprise a hybrid combination of tuned R.F. and double-detection (superheterodyne) systems. Because of broadcasting congestion in the metropolitan areas, a superhet without a highly selective circuit in front of the first detector is now out of the question for interference-free reception.

### High Intermediate Frequency

Now, to get the maximum selectivity from the tuned circuit of the detector, our chosen intermediate frequency must be as high as possible. The reason is clear when an example illustrates the difference between two intermediate frequencies, such as 300 kc. and 1,500 kc.

Suppose the detector tuning condenser is set for a signal of 6,000 kc. (50 meters). For an I.F. of 300 kc., the oscillator will have to tune to a value equal to this signal frequency either plus or minus the intermediate frequency; either 6,300 or 5,700 kc. Suppose we choose 6,300 for the oscillator tuning; if that tuning point is 300 kilocycles away from 6,000 kc., it is also 300 off 6,600. Consequently the oscillator is tuned equally to signals of 6,000 and 6,600 kc., when it is set at 6,300 kc. But the detector (ah!) is tuned only to 6,000 kc. and consequently will reject the average distant station of

(Continued on page 362)











# Remote-Control Tuning and the Built-In Radio Set

*Programs in the music room at the touch of a switch, but the machinery down below*

By JOSEPH ATTARDO

**B**ACK in the good old days, the domestic heating plant was the most conspicuous article of furniture in any home; it has now found its way to the basement. The radio receiver, like the parlor stove, seems to be destined to the same location. While the audio reproducers, it is true, must be placed where they are used, modern practice is tending more and more toward relegating the power plant and set proper to a convenient, though out-of-the-way spot where they can be governed by suitable remote controls.

Practical experience with radio during several years led the writer to devise various methods of reducing the tuning problem to its simplest form; and that which is illustrated here, after thorough development in his home, was finally embodied in a patent application. As illustrated at the right, the control panel, which is set into the dining-room wall, is provided with 36 push buttons. The touch of any one of these tunes in a predetermined station on the receiver, two floors below, which is set in operation or shut off by the toggle switch below. The panel light above indicates whether the system is in operation.

The panel is of a standard type, used in intercommunication systems. Alongside each button is a suitable nameplate, on which the call letters of the corresponding station are printed. The volume of reproduction may be controlled at each speaker by its own variable resistor, if necessary.

The mechanism, illustrated in the photograph reproduced below, is connected to a single-dial standard broadcast chassis, which may be of any good commercial make, or built by the user. When the on-off switch (SW—see Fig. 1) at the control panel is thrown, current is passed through the driving motor; and, as the proper selector button PB is pressed, its corresponding pair of contact points, on the multiple station selector switch, is energized. The shaft

which turns the condensers of the radio chassis drives a gear turning another shaft equipped with a switch arm SA and, when this comes in contact with the line points the relay is energized.

The relay opens the motor's power circuit, stopping the motor at this point; and at the same instant, through a lever, it closes the switch in the loud-speaker circuit of the set, and thus turns on the reproducers upstairs. The actual tuning operation is thus conducted noiselessly, so far as the reproducing system is concerned.

Since the control knob cannot be revolved

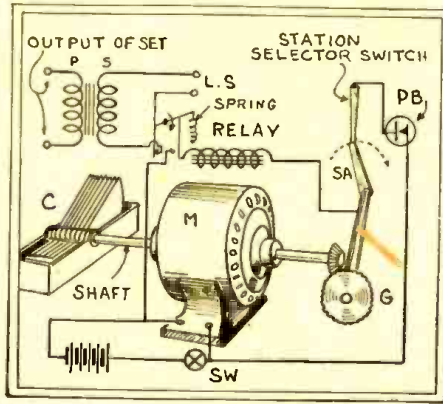

Fig. A

*The essentials of the system; there is one selector circuit for every station.*

continuously in one direction, in modern receivers, a special relay is provided to reverse the motor when the tuning of the set reaches the upper or the lower limit.

Whenever another selector button is pressed, the circuit of the relay which stopped the motor in its progress before is broken automatically; and the motor starts turning again until it has selected a new station. When the power switch is thrown off, the power is shut off from the receiver;



Fig. 1

*The author at the keyboard of his radio set; all wiring is built in.*

but it is in readiness to resume operation on the same station as soon as it is turned on.

In addition, the writer now uses an automatic volume control, which has been set in accordance with the tastes of the household; so that all locals come in with the same volume, and it is therefore unnecessary to touch anything except the tuning buttons and switch.

The number of station buttons, of course, is optional; it may be larger or smaller than that shown.

The advantage of providing wiring accessories for remote radio when constructing a building, just as for lighting and telephone service, etc., is apparent. It is much more easily and satisfactorily done at that time, when the proper conduits may be installed. The push-button panel itself is comparatively inexpensive, and several might be incorporated in a house with only the trouble of connecting a cable from each.

## A SWITCH-TUNED RADIO SET

By Wayne A. Lindsey

**O**NE method of adapting a circuit for rapid tuning to a particular station is to connect adjustable condensers to a switching arrangement; and then vary the position of the switch for each available station.

My radio is a dual-control superheterodyne and I did not wish to change to single-control, because of the advantage of having two tuning points on the oscillator dial. However, most of the broadcasts to which we listen are chain programs, which are carried by one of three nearby stations. Our radio is located in the dining room, because of the difficulty of erecting an aerial if located elsewhere. It was formerly necessary to light up this room and sit down at the radio to tune in another station. Now, it is possible to push a button and tell, even at a distance, which program is being received. While mine is a superheterodyne, the same system is applicable to other types of sets. The changes necessary in my set were as follows:

Three 7-point inductance switches (such as Yaxley or Carter) were secured and an

*(Continued on page 377)*

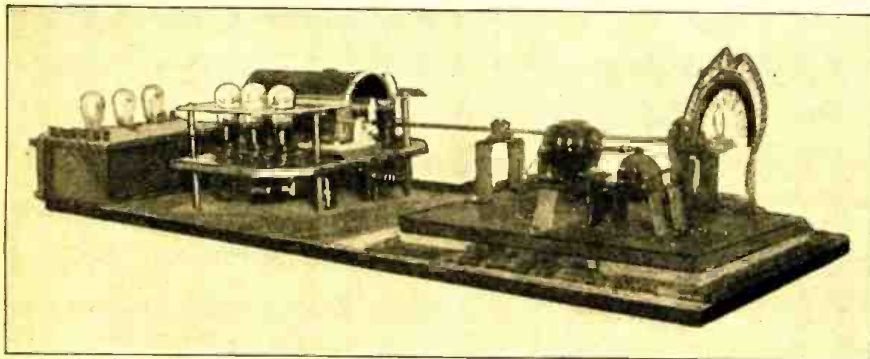

Fig. B

*The receiver, at the left; its tuning condenser is coupled to the rod which links it with the motor and selector switch at the right. Each of the protruding contacts on the semi-circle is arranged as shown in Fig. 1, to stop the motor at a given condenser setting.*



# RADIO CRAFT KINKS

## "TALKIES" RECORDS AS SCANNING DISCS

By Robert P. Haviland

THE idea of using phonograph records as scanning discs is not new. However, the writer (a sound projectionist) wishes to point out that the 12-inch phonograph disc, considered to be a "big" record for home use, does not permit of very satisfactory television reproduction; because its diameter is too small for this sort of work.

On the other hand, the 16-inch records used in talking-movies are very suitable for television use, and they may be obtained from the film exchanges for almost nothing. Find out from the manager of your local theatre the address of the film exchange, nearest your town, and write to them for one or two "synchronized discs" for experimentation. These should have recordings on only one side; which may be defaced.

To prevent breaking, use very light pressure when drilling; follow a carefully laid-out template, which may be paper, pasted to the disc and washed off when you are through drilling.

## TWO NOVEL ADAPTER KINKS

By Jerry Minter

SEVERAL suggestions have appeared in RADIO-CRAFT calling for a tube-socket plug. The most difficult part about these

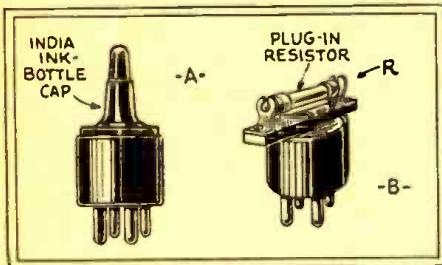

Fig. 1

Two ingenious plug-in devices; A makes a useful switch for some circuits.

plugs is removing them from the socket; some sort of handle is desirable.

An india-ink bottle stopper, a knife, and a tube base, and you have such a handle, as shown in Fig. 1A. The cork is to be cut off; and a hole drilled through the length of the stopper, for the lead wires.

In the July, 1929, issue of RADIO-CRAFT a "detector-booster" was described; and the circuit of this device was shown in the January, 1930, issue. For some time the writer has been using an adapter working along somewhat similar lines.

As shown in Fig. 2B, it is quite convenient to convert a standard short-wave receiver (such as the "Wasp," or the "Super-Wasp") for operation with a phonograph pick-up by plugging into the coil receptacles two little adapter-plugs; one contains tip-jacks for the pickup, and the other carries a

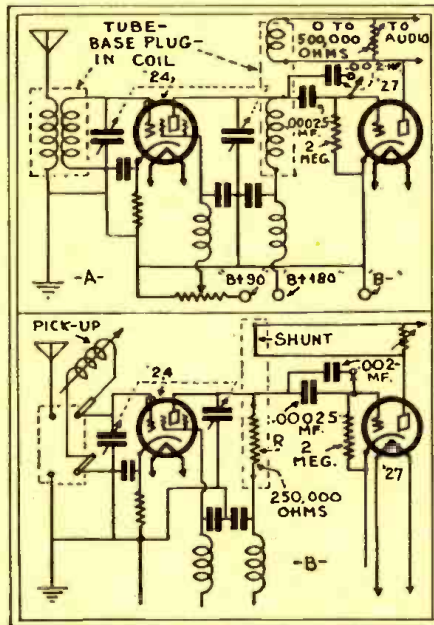

Fig. 2

Below, a method of converting a short-wave set into a powerful phonograph amplifier. Above, the original tuning unit as utilized for short-wave reception.

shunting lead and, on top, a resistor mounting and the resistor R. (Fig. 1B.)

One set which I have in mind used a '24 in the R.F. stage, (which thus was converted into a first audio stage); a '27 detector (which became the second audio); a '26 first audio (now the third); and push-pull '1A's as second audio (now the fourth audio stage); followed by a dynamic reproducer. A good pick-up was used, and the resulting volume and quality were excellent.

## A SIGNAL MONITORING SYSTEM

By S. R. Winters

THE amateur operating a remote-controlled break-in transmitter may well

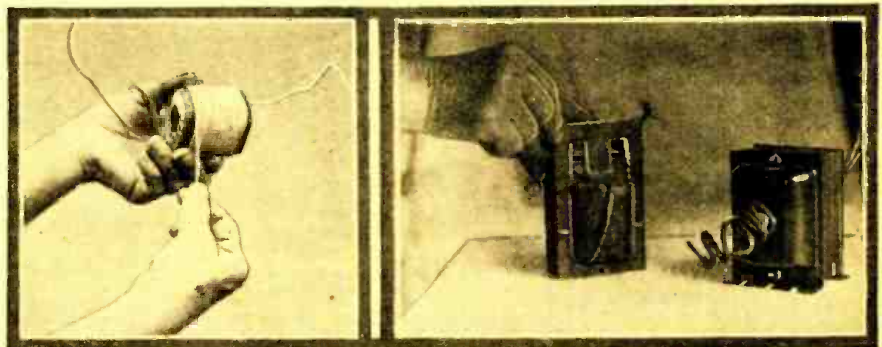

Fig. A

At the left, rewinding a power transformer; at the right, first, replacing the laminations, and finally, the completed instrument, looking as good as new.

Fig. B

read a page from the note-book of the commercial operator.

To the R.C.A. has been assigned a patent covering the use of a neon tube to indicate whether the transmitter is in operation. Of course, this is particularly desirable in the commercial stations, where up to a dozen operators may be sitting side-by-side controlling transmitters radiating to all points of the globe, and where as many transmitters will be in need of constant monitoring. Here there are obvious objections to the use of headphones or loud speakers for this purpose.

As the illustration shows, the output of a radio set tuned to the emitted wave of the transmitter is connected to a neon lamp, placed in front of the transmitter control operator at the remote point. The light indicates by its flickering (translatable at slow speeds) when the transmitter is in operation.

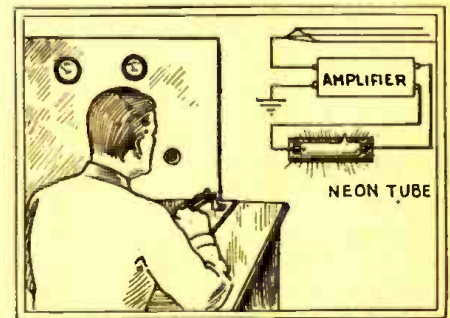

Fig. 3

A commercial idea which may be applied to a "ham" station as well.

## "MODERNIZING" WITH A TRICKLE CHARGER

By John J. Nothelfer

READERS of RADIO-CRAFT may be interested to learn how I adapted the  
(Continued on page 379)



# The Hows and Whys of the Push-Pull Circuit

*The push-pull circuit, it is generally known, gives more power than tubes in parallel; and it gives better quality. The reasons will be explained in a series of articles of which this is the first.*

By EDGAR MESSING

**I**T was but a very few years ago that we began talking about push-pull amplification with some degree of familiarity. That was just about the time when A.C. tubes appeared, and the Service Man stepped out of the "handy man" class. The circuit forced its way rapidly to the front, because there were no power tubes of the heater-cathode type and because a new tube (the '24) made its appearance and without exertion started to feed the audio tubes large chunks which the audio tubes had to bite into smaller bits in order to digest. The process of eating tended to become audible, and we objected. To-day, therefore, most of our good set manufacturers place two tubes in a see-saw arrangement to aid digestion.

The circuit as we shall see, has some very curious twists and we have wondered very much if its inventor, E. H. Colpitts, thought out all the ramifications first, or designed the circuit and let the ramifications make themselves apparent later.

The most apparent of the circuit's good qualities—its ability to handle large inputs—is the first point we shall consider; because most of us are somewhat familiar with this action and will therefore feel on more familiar grounds. In Fig. 1, transformer T represents the coupling device feeding into the push-pull stage. The induced voltage across its secondary (that is, between a and b, for example) is 70 volts; if c is the midtap of the secondary, there are 35 volts between a and c, and 35 between c and b. If a is 70 volts positive with respect to b, then it is 35 volts positive with respect to c, while b is 35 volts negative with respect to c. Since c is connected to the cathode (which is the filament of a three-element tube) of each tube through Rg, and since a and b are connected to the respective grids, V1 has impressed on it a potential of 35 volts positive to its cathode, and V2 has one of 35 volts negative with respect to its cathode. Fig. 2 shows the situation graphically.

The potential of 70 volts has been broken into two parts; which means that two type '71A tubes, with an ordinary power pack, can be used where we would otherwise be compelled to employ the type '50 tube. A 70-volt input might seem somewhat far-fetched for an ordinary home radio set, but some people demand volume and one manufacturer, a very short time ago, put a set on the market that used two 250's in push-pull. This was going a bit too far, of course; but the manufacturer didn't try to create a demand. He was attempting to satisfy one, though a single '71A output tube should easily supply sufficient power for the average home.

The best reason for using tubes in push-pull-however, lies in the elimination of distortion. Let us review somewhat this action of the circuit and, by taking more details than we usually consider, see if we can't get a clear grasp of the why and how.

The first question to discuss is, why we do get distortion? Usually this point is dismissed by showing a graph like Fig. 3, which shows the relation between grid voltage and plate current, and saying that this curve is not a straight line and, therefore, distortion results. Fig. 3, however, does not correspond to the condition under which the tube actually operates. The graph is correct for the set-up indicated at 3B, with the plate connected directly to "B+." In radio sets, however, a resistor or a transformer primary is usually inserted between the tube's plate and the "B" battery or corresponding voltage tap.

Let us see what happens to the characteristic when a resistance is put in the plate circuit. Fig. 4 illustrates this condition. Here, such a negative bias is put on the grid that the tube begins to operate at point a of curve A. During the positive half of an incoming wave, the grid voltage becomes less negative and the plate current increases. This increase, however, produces a voltage drop across R (Fig. 4B), the load resistance; and the voltage on the plate of the

tube becomes less. The plate current then does not rise along curve A but goes to some point on curve B, which is the "static characteristic" of the tube at the lower plate voltage. Similarly, during the negative half of the input wave the current falls back along the line a-c to curve C, which is the characteristic of the tube at a plate potential above that of curve A.

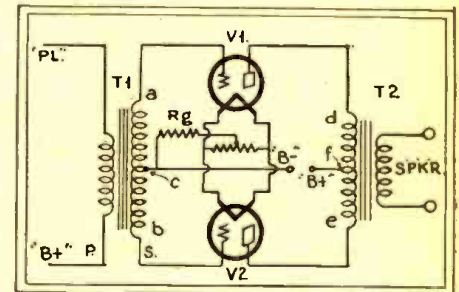

Fig. 1

A standard push-pull audio output stage. The grid resistor is not by-passed.

If we look carefully at the line b-c along which the tube is operated we see that it is practically straight. (If it isn't, the fault is not the tube's, but the artists'). At least, b-c is straighter than c'-c', along which the tube would have operated with no load.

We know that operating along a curved line means that the output does not exactly duplicate the input signal wave; while operating on a straight line means that each input variation is exactly repeated. Fig. 5 shows how our input would have appeared if the tube had operated along c'-c'. (This action will be analyzed later.) The effect of resistance, then, has been to prevent distortion. The dynamic characteristic becomes practically linear when the load resistance equals, or is greater than, the tube's resistance.

The operation of the tube with an impedance load, such as one containing an inductance and resistance, is another and more complicated story.

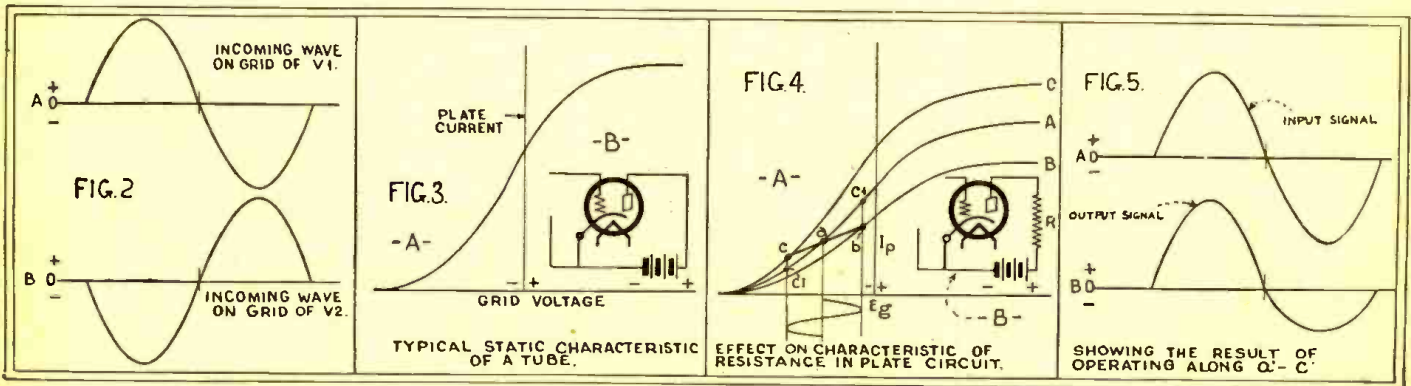

The signals on the grids of two parallel tubes are in phase, naturally, but those on the grids of push-pull tubes are 180° out of phase, as in Fig. 2. In Fig. 3 we have the characteristic of a tube which has nothing but the negligible resistance of its plate battery in the external circuit; while Fig. 4 shows what happens when we begin to load the tube. Fig. 5 indicates the distortion introduced by the variation of the plate voltage which is caused by the signal, or alternating component, in the plate current.



# A New Element in Tube Design

*And some improvements in circuits it would make possible*

By HENRI FRANCOIS DALPAYRAT

IT is well known that the positive charge on the plate of a vacuum tube is not sufficient to capture all the electrons which are emitted by the filament or cathode. The number of electrons emitted depends, not only on the temperature of the cathode, but also on the uniformity of the distribution of heat along the surface of the cathode. Thus, if the cathode is an ordinary directly-heated filament, the electron-emitting surface is likely to be cooler near the supports than in its center.

The result is that the electrons are liberated at different velocities; those from the cooler portions of the cathode shoot off into space for only a short distance, and are then likely to return toward the cathode. From this element, indeed, they are repelled by its strongly negative charge; they hover about it, however, in a "cloud" which is known as the space charge. The space charge acts upon the plate current as a cause of loss; for it reduces the velocity of the electrons passing through it, and causes some of them to fail in reaching the plate. The result is that of apparent higher resistance to the flow of current through the tube, and a lessening of the influence of the control element (*i. e.*, the grid) over the flow of plate current.

It is estimated that 85 per cent. of the plate voltage, in an ordinary tube, is required to overcome the effect of a space charge; while the remaining 15 per cent. or less serves to create an electronic current through the tube. If, therefore, the space-charge effect were overcome, only 15 per cent. of the voltage would be required to pass the same current. Therefore, by maintaining the original plate voltage, we can theoretically increase the amplification factor of an ordinary tube from 6 or 8 to as much as 130 or perhaps 150.

The effect of the space charge, in repelling the electrons back toward the cathode and shielding the plate from them, is a constant factor which is not affected by the incoming signal; it is a load on the tube which reduces its efficiency. The problem

is to remove from the vicinity of the cathode as much as possible of the space charge, without placing any obstruction in the path of the main electron flow.

### A Central Space-Charge Element

The author, after consideration of these matters, has invented and made application for a patent on a new type of tube, into which he introduces a fourth element, intended primarily to reduce the space charge, but which would serve other purposes. This element consists of a small metallic plate, as close as possible to the surface of the cathode, but preferably underneath that element; so that a flow of electrons between these two electrodes does not affect that to the plate. When a suitable positive potential is applied to such a special element or electrode, it will attract the electrons which would otherwise normally constitute the space charge.

It is true that, in present tubes of the screen-grid type, arrangements are possible to apply a potential for the removal of the space charge to one of the intermediate elements; but at the same time, this element obstructs the main path of the electron flow. In addition, only a small positive potential may be applied to such a tube in the "space-charge" hook-up, or the tube will be rendered ineffective. In the tube proposed by the author, the interior location of the space-charge element permits the application of voltage sufficiently high to attract a considerable percentage of the electron emission, and thus make it suitable for stabilizing or amplifying purposes.

The proposed design is that of a tube of standard type, except for an additional element, or metallic conductor, following closely the shape of the cathode and serving to reduce the space charge. If the filament is bent into a V or hairpin shape, this new element may be a metallic triangle, with its edge curved to present a greater attractive surface to the filament; or it may be a metallic ribbon, placed immediately beneath, and following closely, the shape of the cathode.

### Operation of the New Element

When this tube is connected into a circuit, as shown in Fig. 1, and to the innermost element A there is applied a voltage sufficient to overcome the space charge, a current will flow in this element. Since the total emission of the filament is limited (consisting only of the emission to the plate, plus the emission to the auxiliary electrode A) when the plate current is varied by potential modulations of the grid of the tube, the current through A must undergo similar variations which are exactly opposite in phase. By the connections shown, the effect of these two equal and opposite variations are combined in aiding fashion.

It is possible also to apply such a voltage to the auxiliary electrode that the latter will draw a greater current than the plate itself; or the voltage used may be just sufficient to overcome the space-charge effect, and thereby increase the amplification of the tube.

We may also connect the fourth element to a tuning circuit, in such a manner that its voltage will be modulated or varied by the plate circuit; and apply the output to another circuit for further amplification.

It is possible also to use the fourth element for purposes of neutralization. This is done by coupling its circuit with that of the plate, and reversing the connection of Fig. 1; in this case, the changes of phase in the two circuits will oppose each other. The complete oscillatory circuit is closed through the capacity between the fourth element and the plate, and the other interelectrode capacities; which are suitably adjusted, either through the design of the tube, or by means of external connections.

It is possible also to utilize the construction of such a tube to eliminate "audio resonance," caused by the inductance of a coupling transformer, in combination with its distributed capacity; an effect which may cause distortion and singing or buzzing tones. This may be overcome, as generally known, by connecting a resistor across the trans-

*(Continued on page 380)*

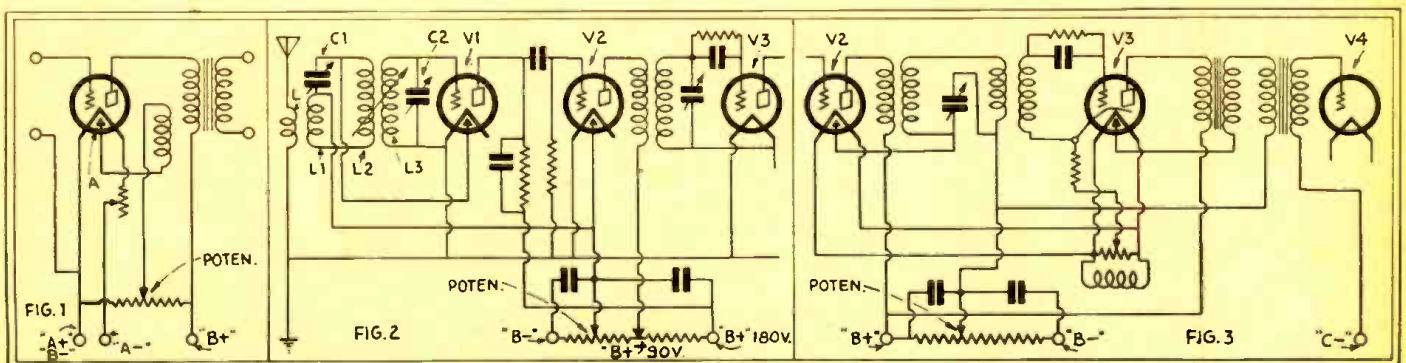

At the left, the proposed intra-cathode element is indicated as A; it may be connected in a circuit either aiding or opposing that in the primary. Fig. 2 shows coupling in an R.F. amplifier, for regeneration or neutralization; and Fig. 3 A.F. coupling as well. These tubes have not been made; but they suggest possibilities of experiment with '24s or '27s, which have indirectly-heated cathodes.





**SPECIAL NOTICE TO CORRESPONDENTS:** Ask as many questions as you like, but please observe these rules:

Furnish sufficient information, and draw a careful diagram when needed, to explain your meaning; use only one side of the paper. List each question. Those questions which are found to represent the greatest general interest will be published here, to the extent that space permits. At least five weeks must elapse between the receipt of a question and the appearance of its answer here. Inquiries can be answered by mail only when accompanied by 25 cents (stamps) for each separate question. Other inquiries should be marked "For Publication," to avoid misunderstanding. Replies, magazines, etc., cannot be sent C. O. D.

**LINE-VOLTAGE REGULATORS**

(96) Mr. L. K. Waldron, Pittsfield, Mass. (Q.) Some time ago (in the September, 1929 issue of RADIO-CRAFT, to be exact) there was described a line-voltage regulator for use in series with the primary of the power transformer. Are any commercial radio sets designed to use this unit, which was made by Amperite?

(A.) A number of radio manufacturers have designed their sets to accommodate this regulating resistor. As stated in the article, a special transformer is required, having a primary winding designed for 85 to 95 volts (the voltage applied to the transformer primary when the regulator is in circuit). The following sets provide for this regulator: Air Knight, Admiral, Asonian, Bremer-Tully, Brunswick, Crown, Electra, Farm-Lite, Grebe, Harrison 77, LaPeer, Melotrope, Windsor 7, Nation, (10-20); Continental (two, 18-10); Hi-Q 30, Kylectron, Peerless, Pioneer, Remler 111 (11-20); Silver Radio (10-25); Scott A.C. 10 1930 model (12-20); Victor R-32, R52, RE-45 (10-V-10 and special adapter). Resistor type numbers are given in parentheses.

**DIRECT-COUPLED AMPLIFIER**

(97) Mr. Abel Caring, Leavenworth, Kan. (Q.) Having built a direct-coupled amplifier, I have observed the characteristic lack of volume when a two-tube amplifier is coupled directly to the antenna; as Mr. Sterns pointed out in his article on direct-coupled amplifiers, in the September, 1930, issue of RADIO-CRAFT. Then, too, I have found a regenerative detector and single-stage audio (using type '99 tubes) to be superior in volume and selectivity. Is this a natural condition for such a set-up?

However, there is a much greater trouble than this in the set I constructed; it hums very much.

Would increasing the size of the filter system take care of this? It is desired to apply this amplifier to a special audio system, also, for amplifying very small sounds, but the present amount of hum precludes this. Grounding the set has not remedied the trouble; and neither has coupling the amplifier through a good transformer to a separate detector.

(A.) This matter received the personal attention of the author of the article mentioned; and here is what Mr. Sterns replied:

"I am a firm believer in resistance-coupled amplifiers and have yet to find anything to beat them; but it has been hard to get sufficient volume in the output, because of the last tube's overloading. The Loftin-White amplifier solves the difficulty with the last tube and, combined with the straight resistance coupling, makes the ideal amplifier.

"Several amplifiers delivering 15 watts output have been built by the writer and would completely cover the audio range of 10 to 30,000 cycles without noticeable variation in output; the maximum variation within these frequency limits was two dB (a value taken as a practical figure for a perfect amplifier).

"When using the regulation Loftin-White amplifier, you will find a marked diminution in the high frequencies which are required to give brilliancy to music and intelligibility to speech.

"In its present form the L-W is not easily connected to a radio set, owing to the ingenious differential input circuit which requires a very high input impedance. This situation is best met with resistance coupling to the detector.

"Regarding hum, it may be remarked that this is one condition that has never caused the writer any serious concern; because the "bucking-out" condenser, C1 in the original diagram (Fig. 2,

page 156, September RADIO-CRAFT) certainly does eliminate the hum; and there is no necessity to increase the filter. A little experimenting with various values of fixed condensers (perhaps one or two of those now in the set are open circuited) will probably result in eliminating the hum. This procedure is considered preferable to increasing the impedance values in the filter circuit.

"In passing it might be of interest to mention that the writer once constructed at the Bell Telephone Laboratories a 19-stage amplifier so sensitive that, when a fly walked across the resonator of

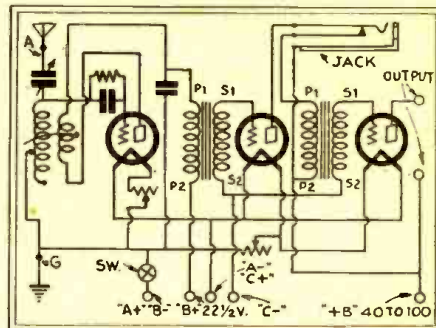

(Fig. Q.98) The "Model 52" regenerative 3-tube Crosley is also quite out of date, but may well be adapted to various needs, as an oscillator, "portable," etc.

a tuning fork to which was attached a microphone button, a 100-watt lamp in the output would flash. In a clinic room that amplifier, with a good dynamic speaker, would have made heart beats sound like sledge-hammer blows!"

**CROSLY 52, 5-50 AND 5-75**

(98) Mr. Edward V. Secor, Babylon, N. Y. (Q.) I would like to know whether wiring diagrams of the Crosley models "52," "5-50," and "5-75" are available. These are battery sets, and just how these early models were connected is not clear; as the ones in the shop are not completely wired.

(A.) These are not reproduced in the ordinary circuit references; because they are particularly old radio sets, whose circuits have nearly passed out of sight. However, they are shown in these columns; together with available data. The connections provided for the use of additional "B" and "C" voltages are shown in dotted lines.

**"B" FROM STORAGE "A"**

(99) Mr. James D. Snyder, New Tripoli, Pa. (Q.1) I read with particular interest the article in the July, 1930, issue of RADIO-CRAFT, "B" Power from a Storage Battery," by L. B. Robbins, as I have been requested to build a converter of this type; but it must operate under somewhat different conditions. I would like to use a 32-volt farm-light plant's storage battery instead of a 6-volt, 150-amp. storage battery to drive the converter. The converter output should be capable of supplying 110 volts A.C. for an 8-tube screen-grid receiver.

(A.1) To this inquiry the author makes this reply: "The converter described by me was used (Continued on page 380)

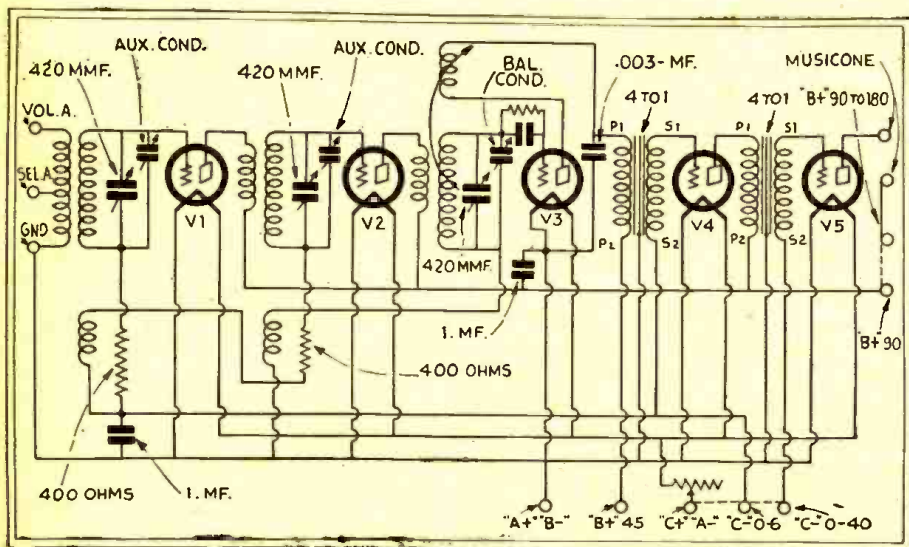

(Fig. Q.98) The Crosley "Models 5-50" and "5-75" receivers; bygone relics. It is not worth while to do much with such a set in the way of improving it.





# Pick the Job You Want and Fill It...in a Few Months!



*Prepare at Home*

Only an hour or so a day is all you need. This Big League training prepares you for success in all phases of radio . . . manufacturing, servicing, selling, ship and shore broadcasting, photo-radiograms, radio equipment. Our graduates are now in demand everywhere . . . because they are posted right up to the minute in everything in radio. Radio's progress each year is measured by the accomplishment of the great engineers at work in the research laboratories of the Radio Corporation of America. This world-wide organization sets the standard for the industry . . . and stands back of every lesson in the course! A signed agreement by the president of the school assures you absolute satisfaction upon completion of the training—or your money will be promptly refunded.

By means of an actually proven kind of home study training sponsored by the Radio Corporation of America, hundreds of ambitious fellows are today enjoying financial independence in work that is thrilling.

Radio needs you. Opportunities are begging for men. Good money . . . fascinating work . . . adventure galore! Read all about this tremendous modern industry . . . send for this magnificent free book. Mail the coupon now!

**THE ONLY COURSE IN RADIO SPONSORED BY RCA**

**RCA INSTITUTES, INC.**  
(A division of Radio Corporation of America)



RCA INSTITUTES, Inc.  
Dept. SRA-12  
75 Varick St., New York, N. Y.

Gentlemen: Please send me your big FREE 40-page book which tells about the brilliant opportunities in Radio and about your famous laboratory-method of guaranteed radio instruction at home.

Name .....

Address .....



## HEADQUARTERS FOR HEADSETS

Even during the rapidly progressing years of radio there still remains need, for broadcast and testing purposes, experimental work and short-wave reception, of headsets of precision manufacture and quality workmanship. The products presented below are made by the largest manufacturers of radio headsets in the world—products that have been recommended for years and years and need no introduction to the radio trade.

### BRANDES and CANNON-BALL Products



#### BRANDES Matched Tone Headsets

Standard and reliable since 1908. Brandes Headsets have been used continually through these long years and have given remarkable service. They still occupy first position among headsets used throughout the world.

Superior, 2,000 Ohms Resistance. List price \$4.50

#### CANNON-BALL Headsets

The popularity of Cannon-Ball Headsets is a tribute to their high quality. Aluminum cases, double magnets and double poles. Quality built. Popular priced.

Dixie, 1,800 Ohms Resistance. List price \$2.25

Senior, 2,000 Ohms Resistance. List price \$3.00

Master, 2,200 Ohms Resistance. List price \$3.50

#### CANNON-BALL Single Phone

Used principally with Crystal Sets. Low in price and gives very satisfactory reproductions.

Dixie Single, with 4½-ft. cord and braid headband. List price \$1.50.

Dixie Single, with 4½-ft. cord without headband. List price \$1.25.

#### PANDORA Crystal Set



Selective and efficient. Receives broadcast reception loud and clear from stations within a radius of 25 miles. Of metal construction and enameled in various colors. List price, with crystal, \$2.50.

**CANNON & MILLER  
COMPANY, Inc.**  
Springwater - - New York

## A New Television Synchronizer

(Continued from page 351)

The driving motor B may be any small variable-speed motor capable of rotating the disc at the desired speed. The signal for the synchronizing amplifier of Fig. 1 is obtained by tapping off, at R, a small fraction of the output of the television receiver.

The easiest way to explain the operation of the arrangement is to consider it in actual operation and analyze the various phenomena taking place. If a 720-cycle signal from a picture transmitter is fed to the grids of the output tubes (V2, V3), they will be swung alternately positive and negative in a degree dependent upon the signal strength. If at any time a positive potential is supplied to the plate of one of the tubes, at the same instant that the grid assumes a maximum positive value, a heavy plate current will be drawn; and the load thereby placed on the generator will tend to cut down the speed of rotation of the system as a whole.

Now, with a strong signal applied to the grids of the output tubes, we gradually increase the speed of the driving motor. At a certain instant, the grid of one of the push-pull tubes will have its grid positive at the same time that the induced plate potential from the alternator A assumes a positive value. When this occurs as the speed of the drive shaft reaches 900 r.p.m., in the next half-cycle of the signal, the grid and plate of the other output tube will also become positive; thus placing a heavy load on the driving motor. If, however, the speed is less than 900 r.p.m. the condition of maximum grid voltage with maximum plate voltage does not obtain in the opposite tubes in

successive half-cycles of the signal, and the braking effect is not at a maximum value.

With the main driving motor adjusted to rotate at a speed slightly greater than synchronous the system will pick up speed, after the braking action, until the synchronous condition is again reached. After the retarding-increasing cycle has been repeated several times, the two actions will become so closely interlocked that there will be no noticeable variation in the speed of the disc during operation.

#### The Image Takes a Hand

There is one peculiar effect to be noted, when synchronization is achieved in this manner. If a sharp bright vertical line is present in the image, it will have an effect on the synchronization. If, for example, a female singer in white clothing is being televised, and the subject moves back and forth across the scene, the motor will follow the motion in such a manner that the singer will appear to be standing still and the image as a whole moving.

With a generator of this type, it is necessary to apply direct current to the field coils. If we employ an alternator of the "phonic-wheel" type, the rotor will have half the number of segments employed when operating as a motor without D.C. excitation. For a generator driven at 900 r.p.m. and delivering 720-cycle current, the number of teeth required in the rotor may be obtained by dividing the frequency of the desired current by the rotational speed in revolutions per second; thus, dividing 720 by 15 gives 48. With a motor employing no D.C. excitation, the number of segments would be double this.

## Selecting the Intermediate Frequency

(Continued from page 353)

medium or weak strength; although this distant fellow may be exactly on 6600 kc., the oscillator's second effective signal frequency. If, however, the 6600 kc. station is nearby and strong, its signal finds little difficulty in passing through the detector tuning circuit set for 6000 kc., which is only 10% off the station's own frequency.

But if the I.F. is 1500 kc., the sum-frequency of the oscillator is 7500 kc. when the detector is tuned to the 6000 kc. station. A second station at, say, 9000 kc., also 1500 kc. (the difference-frequency) away from the oscillator, would be detuned from the detector by 50% instead of 10%. This difference in selectivity is far more effective than the five-to-one ratio expressed by the percentage figure.

There is another reason for the usefulness of such a high I.F.; this is the fact that, if the detector tuning is limited, the oscillator tuning may be designed for either of the oscillator's possible tuning points. A 300-kc. I.F. would thus give two tuning points 600 kc. apart, equal in results but capable of interference if there are stations on both frequencies. A 1500-kc. I.F. would give tuning points 3000 kc. apart; and therefore there would be no possibility of inter-

ference between stations on both tuning points, because of the great difference between them.

But we may also limit the detector and oscillator tuning ranges to somewhat less than 3000 kc., and keep the repeat point entirely off the dial, without seriously impairing the flexibility of the set. This is done in a short-wave super, designed by the writer, called the "HY-7." This has a third merit of permitting the oscillator to cover two tuning ranges with two plug-in detector coils and only one oscillator coil. Which is to say that an oscillator coil for heterodyning signals between 6000 and 9000 kc. will also heterodyne with signals from 9000 to 12000 kc., which are tuned-in by the use of another detector coil.

We know of course that effective amplification is possible at this frequency of 1500 kc.; since broadcast receiver practice has shown that screen-grid tubes give excellent results at 200 meters. However, since there are broadcast stations on or near that wave, we will have to depart from it slightly. A satisfactory compromise value is 1550 kc., slightly below 200 meters and always clear of broadcast stations; unless an exceptionally powerful local on 1500 kc. should force itself through.



INSULINE CORPORATION OF AMERICA — Manufacturers of Radio & Television Products

### I. C. A. Variotone Tone Control

**T**HE VARIOTONE, a new product not to be confused with any type of volume control, is a scientifically designed instrument for the regulation and control of tonal quality. Its use with old receivers, also those of modern design, perfects tonal quality and shading beyond anything that has yet been introduced to improve reception. With the VARIOTONE adapters placed under the power tubes, the proportion of the treble and base frequencies given off by the loud speaker may be regulated at will. The VARIOTONE enables the characteristics of the receiver and speaker to be more exactly matched; also, to regulate broadcast reception according to the acoustic properties of the room. Perfect blending of tones—more joyful programs are the result of the VARIOTONE.



List Price \$3.75



List Price \$2.50

### I. C. A. Insultenna---Aerial Eliminator

*A Startling Invention to Replace Outdoor and Indoor Antennas*

**T**HE INSULTENNA is a remarkable modern aerial substitute—compact in size and easily hidden from view by placing it within the radio cabinet. It is not a light socket aerial and has absolutely no electric connections for current lines—thus all possibilities of hum are eliminated—lightning arresters are also unnecessary. The INSULTENNA measures only 5" x 2½" x 1" and contains a number of feet of new type filtered aerial wire and condensers which gives it the capacity of 75 feet of ordinary antenna. This modern aerial has many advantages over the old type antenna.

### Dealers and Servicemen---

Your proficiency as dealers and servicemen lies not only in your ability to render efficient service to your clientele but also to admonish them in ways to get greater enjoyment from their radio. In recommending INSULINE Products for various needs, you are certain that many years of experience in actual testing and manufacture lie behind every piece of radio accessory. INSULINE Products represent quality materials and precision engineering.

Manufacturers Endorse

INSULINE Products - -

From the dozens of manufacturers who have found it economical and worthwhile to use INSULINE Products there is certainty that our research laboratories, consisting of a large staff of radio engineers, are qualified to manufacture products of the better kind. Their requirements, of various construction, have been carefully fulfilled by INSULINE—Manufacturers of insulating materials, radio and television apparatus and hundreds of radio parts.

### A FAST SELLING LINE - -

INSULINE CORP. OF AMERICA RC-12  
78-80 Cortlandt St., New York, N. Y.

Enclosed find \$.....for which you are to send me, postage prepaid, the item checked.

- I.C.A. VARIOTONE TONE CONTROL.....\$3.75
- I.C.A. INSULTENNA—AERIAL ELIMINATOR.....\$2.50

Name.....Address.....  
City.....State.....

Dealers write for Catalog showing complete line of I.C.A. Products.

**Insuline Corp. of America**

78-80 Cortlandt Street - New York, N. Y.



# Announcement!



## NATIONAL RADIO SERVICE MEN'S ASSOCIATION

### BOARD OF DIRECTORS

- L. M. Cockaday*
- David Grimes*
- John F. Rider*
- Hugo Gernsback*
- Sidney Gernsback*
- I. S. Manheimer*

**E**VER since the appearance of the commercial radio broadcast receiver as a household necessity, the Radio Service Man has been an essential factor in the radio trade; and, as the complexity of electrical and mechanical design in receivers increases, an ever-higher standard of qualifications in the Service Man becomes necessary.

The necessity, also, of a strong association of the technically-qualified radio Service Men of the country is forcing itself upon all who are familiar with radio trade problems; and their repeated urgings that such an association must be formed has led us to undertake the work of its organization.

This is the fundamental purpose of the NATIONAL RADIO SERVICE MEN'S ASSOCIATION, which is not a money-making institution, or organized for private profit; to unite, as a group with strong common interests, all well-qualified Radio Service Men; to make it readily possible for them to obtain the technical information required by them in keeping up with the demands of their profession; and, above all, to give them a recognized standing in that profession, and acknowledged as such by radio manufacturers, distributors and dealers.

To give Service Men such a standing, it is obviously necessary that they must prove themselves entitled to it; any Service Man who can pass the examination necessary to demonstrate his qualifications will be elected as a member and a card will be issued to him under the seal of this Association, which will attest his ability and prove his identity.

The terms of the examination are being drawn up in co-operation with a group of the best-known radio manufacturers, as well as the foremost radio educational institutions.

The following firms are co-operating with us:

- GRIGSBY-GRUNOW CO (Majestic), CHICAGO
- STROMBERG-CARLSON TELEPHONE MFG. CO., ROCHESTER, N. Y.
- CROSLY RADIO CORP., CINCINNATI, OHIO
- COLIN B. KENNEDY CORP., SOUTH BEND, IND.

The schools who have consented to act as an examination board are:

- International Correspondence Schools, Scranton, Penna.; Mr. D. E. Carpenter, Dean.
- RCA Institutes, Inc., New York, N. Y.; Mr. R. L. Duncan, President.
- Radio & Television Institute, Inc., Chicago, Ill.; Mr. F. G. Wellman, Managing Director.
- Radio Training Association of America, Chicago, Ill.; Mr. A. G. Mohaupt, President.
- School of Engineering of Milwaukee, Milwaukee, Wisc.; Mr. W. Werwath, President.
- Rider-Goll Radio School, New York, N. Y.; Mr. John F. Rider, Director.
- Radio College of Canada, Toronto, Canada; Mr. J. C. Wilson, President.
- Radio Division, Coyne Electrical School, Chicago, Ill.; Mr. H. C. Lewis, President.

We shall not attempt to grade the members into different classes. A candidate will be adjudged as either passing or not passing. If the school examining the papers passes the prospective member as satisfactory, we shall issue to him an identification card with his photograph.

If the candidate does not pass this examination the first time, he may apply for another examination three or six months later.

There is absolutely no cost attached to any service rendered by the Association to its members, no dues, no contributions.

If you wish to become a member, just fill out the coupon below and mail it to us. We will send you all the papers necessary to become a member.

N. R. S. M. A.,  
c/o RADIO CRAFT,  
98 Park Place,  
New York, N. Y.

I wish to become a member of your Association. Please mail be the examination papers and application blanks.

Name .....

Address .....

Town..... State.....





# Why Servicing Grows More Complex

(Continued from page 328)

the record-cutting system are already here, and they all will require service.

The variable-frequency tone control was another innovation heralded at the show. Such tone-control systems are more complex than in days gone by, and consist of more than a number of condensers which may be switched in and out of the circuit. The fact that the new systems introduced are relatively simple is no disproof of the fact that later systems will be more complex. Signs of such systems are now appearing in the press and show that, while the operation is simple, the operating principles are complex. The service problems related to such tone-control systems make necessary a thorough knowledge of the principles and applications of resonant circuits in audio-frequency systems, the relations between the parts of the systems, and the functions of the individual units. In time to come, every Service Man will be obliged to understand the complete principles of the audio-frequency transformer, the auto-transformer, and the tuned double-impedance system.

The use of the band-pass filter in the audio-frequency amplifier, and in the intermediate-frequency amplifier of the superheterodyne receiver, is daily increasing in popularity. Troubles in such systems can be solved only when the operator is familiar with their presence, purpose and characteristics.

Speaking about superheterodynes, the revival of that receiver type starts anew an

old problem; that of beat-notes or heterodyning in receivers. Troubles of this nature were solved with little difficulty with the conventional tuned radio-frequency system and, if not solved, they were dismissed by placing the blame upon the design of the receiver, or the proximity and power of a neighboring transmitter. That is not possible with the superheterodyne, because of the design of the receiver. The system used to combine two frequencies of different value is different from the ordinary tuned radio-frequency system. There are peculiarities of operation associated with superheterodyne receivers which are not found in any other system of reception. These peculiarities must be studied and known.

The presence of the oscillator will make necessary a more complete conception of the function and operation of such circuits. Perhaps this will do much to illuminate the correct operation of test-circuit oscillators; but, be that as it may, the fact remains that the components and characteristics of oscillating circuits will have to be studied.

Service work is becoming more and more complex each day, because the radio receiver is becoming more and more complex each day. Every new development, every new combination of the radio receiver with some other system, is going to make service more difficult and better worth while. Service Men will eventually be engineers. Prepare as you go along!

# Leaves from Service Men's Notebooks

(Continued from page 329)

will swing the needle clear over to full scale. With one end of the resistance wire already fastened to the terminal, the other end is touched to the other terminal. When the proper amount of wire is used, the needle will register exactly half of the scale. When the correct length of resistance wire is determined, it is fastened to the terminal of the meter. Thus, if a 100-milliamperere meter is to be increased to 200, a full load of 100 milliamperes is passed through the meter; with the correct resistance, the meter should read 50 milliamperes.

If a 100-milliamperere meter is to be increased to take one ampere (or 1,000 milliamperes) the full load of 100 mills. is passed through the meter, and the correct length of resistance wire will give a reading of 10 milliamperes. To use the meter, the reading should be multiplied by ten. Several resistors can be used to give various ranges if switches are used or phone tips and tip jacks to cut in and out each resistor. The same principle can be applied to A.C. ammeters.

## SOME SET PECULIARITIES

By Henry Burwen

WHILE all manufacturers caution against removing tubes while the power is on, this caution is very often disregarded by the Service Man. On the new Fada D.C. models, however, it is extremely important to pay attention to this caution. The six 71As are in series and, if one tube is inserted with the juice on, it is very

likely to blow the whole six. Also the "Flashograph" pilot light is connected across the first audio '27 and, if that tube is removed, the Flashograph bulb is likely to blow.

The Majestic "90" series are rather critical as to setting of the balancing adjustments and, generally, they have to be rebalanced after being in service a few months.

Recently I found one of these sets in an oscillating condition and tried balancing it. I went through all the usual processes, using a dummy tube, but could not get it balanced. I tried shifting tubes, and repeated the neutralizing process several times with the same result.

Finally I discovered that the ground wire was disconnected at the lightning arrester. Remedying this fault made it possible to overcome the oscillation.

## Steinite Troubles

When you find a Steinite "70" set completely dead, except for the slight speaker hum, the first thing to suspect is the by-pass condenser across the plate and ground of the R.F. tubes. Shorting of this condenser is a frequent occurrence in this model.

A quick test to determine this is to take out the detector tube and put it back, noting whether you get the click in the speaker. Then remove one of the '24s and, if there is no click on putting it back in the socket, you can almost take it for granted this condenser is gone.

A socket test will show partial or no "B"

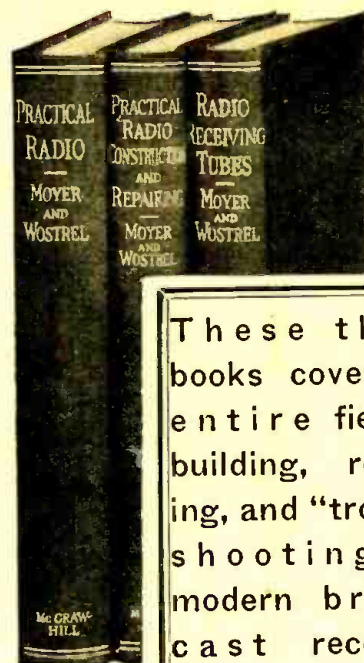

These three books cover the entire field of building, repairing, and "trouble-shooting" on modern broadcast receiving sets.

993 pages  
5 1/2 x 8 inches  
fully  
61 illustrations

This Library serves alike the needs of the commercial radio dealer, installer and serviceman, and the amateur who keeps abreast with the latest trend in radio by building his own sets.

The Library is up-to-the-minute in every respect and is based on the very latest developments in the design and manufacture of equipment. The rapidly-growing interest in short-wave reception is thoroughly covered in a complete section which deals with the construction of this type of apparatus.

# Radio Construction Library

By JAMES A. MOYER and JOHN F. WOSTREL

Faculty, University Extension, Massachusetts Department of Education

Three Volumes — 993 Pages, 6x9  
561 Illustrations

THESE three books embody not only a thorough home-study course, but a ready means of reference for the experienced radiotriician. Step-by-step information is given on wiring, "trouble-shooting," installation and servicing to get the best tone quality, distance and selectivity in broadcast reception in all types of sets.

Practical data is given on radio equipment such as antenna systems, battery eliminators, loud speakers, chargers, vacuum tubes, etc., etc.

A section is devoted to the identification of common faults in receivers and methods of making workmanlike repairs.

The three books are profusely illustrated with understandable diagrams of hookups, connections, loud speaker units, installation work and antenna erection—as well as numerous photographs, tables and charts which clarify the text.

See this Library for 10 Days Free  
No Money Down — Small Monthly Payments

It is your privilege to examine this Library for 10 days without cost. If they prove satisfactory, send an initial payment of only \$1.50 and \$2.00 a month until \$7.50 has been paid. Otherwise return the books.

McGRAW-HILL

FREE EXAMINATION COUPON

McGRAW-HILL BOOK COMPANY, INC.,  
370 Seventh Avenue, New York.

Gentlemen—Send me the new RADIO CONSTRUCTION LIBRARY, all charges prepaid, for 10 days' Free Examination. If satisfactory I will send \$1.50 in 10 days, and \$2.00 a month until \$7.50 has been paid. If not wanted I will return them at your expense.

Name .....

Home Address .....

City and State .....

Position .....

Name of Company.....RC-12-30



**Bring Your Radio Set  
Up-to-Date  
by adding the  
CLAROSTAT  
TONE CONTROL**

The outstanding feature of the latest radio sets, Tone Control, is now available to owners of any and all radio sets. The Clarostat Tone Control is a universal device easily connected by slipping the adapter discs under the power tube or tubes.

Neat case with felt base. Flexible leads and adapters complete for simple application without tools or special knowledge.

A turn of the knob gives control from "Bass" to "Treble."

List Price ..... \$2.35

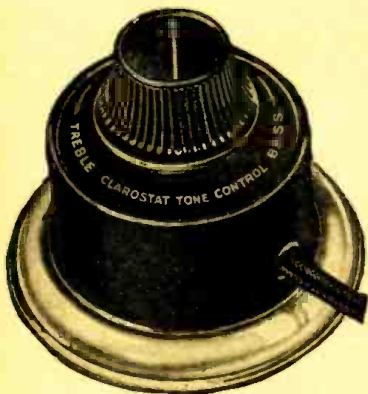

**Special Introductory Offer!**

As a special offer to readers of RADIO-CRAFT, who we know are our best boosters, we will supply this \$2.35 item for \$1.25 and coupon below.

NO C.O.D.'s  
NO COUPON—NO SPECIAL PRICE  
OFFER EXPIRES DEC. 30, 1930

CLAROSTAT MFG. CO., Inc.  
285 North Sixth Street, Brooklyn, N. Y.  
Gentlemen:

As offered to RADIO-CRAFT readers, please RUSH to me one Clarostat Tone Control at the special price of \$1.25. Payment is enclosed.

Name .....  
Address .....

**Clarostat Mfg Co., Inc.**  
285 North Sixth Street  
Brooklyn, N. Y.

**Dealers  
Servicemen !**

We are headquarters for  
JEWELL and WESTON  
Testers, Set Analyzers and  
Meters.

Maximum Discounts

**SUN RADIO CO.**  
64 Vesey St. N. Y. City

voltage on the '24 plates, and continuity test will show a complete short or an abnormally high reading across the condenser. A similar reading can be obtained across the ground and the third (or next to highest) tap on the voltage divider. This tap feeds the '24 tubes and the condenser is across this tap and ground.

The condenser in question is one of a bank of four similar units readily discernible from inspection underneath, and is the only one of the four that has three wires soldered to its high side.

For replacement use an 0.5-mf. condenser of 700 volts rating. Simply cut the defective condenser out of the circuit, leaving it in place. Attach the new condenser to the bolt holding one end of the voltage divider, and run a wire over to the three you have clipped from the shorted unit.

If no replacement condenser is available, an emergency job can be done without it.

Shift the wire from the R.F. voltage tap on the divider (next to the high) up to the high-voltage tap. The set will operate fairly satisfactorily with these connections.

Another common trouble on this set is the breaking of the cable; this is usually caused by the cable's sliding around the drum at the end of its turn when the operator keeps on turning the knob; thus fraying and shearing off the cable. It may also be weakened where it fastens to the bolt on the shaft, from the bolt's being tightened down on it. To remedy both these troubles, on putting in a new cable put a drop of solder at the point where the tension spring makes contact with the cable. On fastening the end of the cable to the bolt, tighten only slightly, then solder.

Whenever you have one of these chasses out, always inspect the two bolts to which the "on-and-off" switch are connected; they are almost invariably found loose.

**Operating Notes for Service Men**

(Continued from page 330)

Choppy reception, or none, on the Atwater Kent "37," "40," etc., and Kolster "K20" sets, when not caused by tube or voltage troubles, may be due to a broken-down or open speaker condenser. In the A.K. models, "shooting" the condenser with high voltage, or 110-volt A.C., may be tried.

In a Zenith "52," which had previously been serviced by several men, an unusually difficult case of fading was recently encountered. The volume control and the Mershon electrolytic condenser had previously been condemned and changed; tubes had been tested, retested and exchanged. After a thorough overhauling by tightening up all screws and nuts, realigning the condenser gang, testing all by-pass condensers by charge-and-discharge methods, the receiver was taken to a convenient place to resolder all connections. The trouble was then found in the tiny wires which are

fastened to the eyelets of the small R.F. chokes under the chassis, and at the points where the wire passed up through the eyelets. The complaint in this case was not gradual fading, but sudden rise and fall of volume; and repairs at the points mentioned remedied the trouble.

When a manufacturer urges the use of a certain make of tube, it means usually that it will be necessary to rebalance the tuning circuit to compensate for the characteristics of other tubes; as in the Radiola, Fada and Bosch.

A tube with too high a plate current is sometimes noisy, and will spoil reproduction from a good set.

In the Spartan "930," or similar sets, unmatched or gassy "Type-182" power tubes will cause a hum which is annoying and difficult to locate.

**Automatic Volume Control**

(Continued from page 335)

connected between the plate of the control tube and ground; whereas the D.C. current produces a voltage drop across R4 and R5. The direction of the voltage across both resistances, or across one resistance, is such that it may be applied to the grid of the radio-frequency amplifier tube; and it will be additive to the normal bias secured via R1. We show a connection from the junction point between R4 and R5 to the grid of the radio-frequency tube through the isolating resistance R3. Hence the bias developed across R4 is added to the normal bias across R1.

The bias provided for the control tube is of such value that a predetermined signal voltage is required to swing the grid and cause the flow of current, in the control tube's plate circuit, to increase the bias applied to the radio-frequency tubes; thereby reducing the volume output of the receiver.

If so desired, the voltage drop across the resistors R4 and R5 can be distributed to more than one tube, and in any proportions; depending upon the positions of the taps and the resistance values between taps.

**Service Considerations**

In view of the potentials present in such volume-control circuits, ordinary methods of analysis by means of set analyzers are not generally satisfactory. As a matter of fact, they are entirely unsatisfactory. It is necessary that the operator consider the control circuit as a separate entity and determine its operation by its effects upon the associated circuits and by individual testing of the respective components employed in the control circuit.

The condition of the tube (that is the control tube) is very important, and insufficient, as well as excessive, electronic emission impairs the operation of the system. The first condition is usually indicated by lack of volume control; and the second by weak signals due to the production and application of excessive control bias, or by excessive reduction of tube plate voltages, when the form of control is of that character.

(This interesting article by Mr. Salz is printed by courtesy of *The Electrad Forum*.)



## Testing Equipment of Service Men

(Continued from page 337)

pulled up to examine the wires. So, taking the live, or ungrounded, 100-volt A.C. wire, by passing it through a 100-watt lamp and connecting to the ground wire, it was found that the ground was open. The radiator was grounded; for the lamp immediately flashed up when the wire was touched to it. Another wire, run around the molding and connected to the radiator, cured the set of its ills.

This method is especially useful in the country, where the ground is made by a pipe driven into the ground. The efficiency of the ground is poor if the bulb burns dim, and good if the bulb burns brightly. The aerial can be tested in this manner for grounding.

### TESTER ATTACHMENT FOR SCREEN-GRID TUBES

By Frank L. Dodd

**S**ERVICE MEN and several dealers have asked me how I changed over my tube tester (a Sterling "510") in order to use it on screen-grid tubes. Probably there are others who would be interested to read about this through RADIO-CRAFT; so I am submitting it here.

In the tester mentioned (as also in the "R-509") there is a resistor connected to the grid prong of the UY, or 5-prong socket. Unsolder this connection, leaving the "G" of this socket connected to the "G" of the UX socket on the tester. Then connect this resistor (which leads on the other side to a switch button) to a double-pole double-throw switch; which is to be mounted on the side of the tester, and to one center terminal of which is attached a suitable lead and screen-grid cap as shown in the diagram herewith. When this switch is thrown

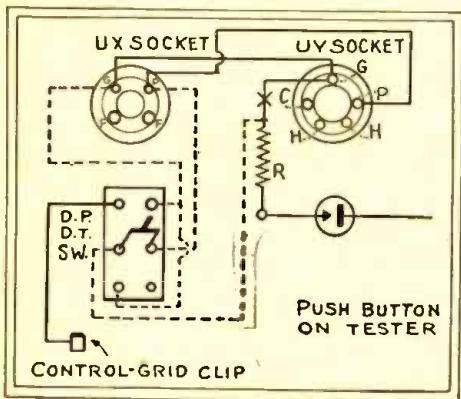

Fig. 3

This switching connection, applied to an old-style tester, makes it easy to take readings on the screen-grid tubes.

down, ordinary UX and UY three-element tubes may be tested. When it is thrown up, and the cap lead applied to the cap of a '22 or '32 in the UX socket, on a '24 in the UY socket, readings on these tubes may be taken in the regular manner.

The filament-emission and plate-current readings of the '22 and '24 will be similar to those for other tubes listed in the instructions supplied with the tester; filament emission 40 to 65; plate current, button up, 1 to 2½; plate current, button down, 4 to 7. I have not yet had a chance to test the UX-'32; but the same principles will apply.

# PATENTS INVENTORS

**Write for these  
FREE BOOKS!**

**MY PATENT  
LAW OFFICES  
OPPOSITE  
U.S. PATENT  
OFFICE**

At the left is a view of my drafting and specification offices where a large staff of experienced experts is in my constant employ. All drawings and specifications are prepared in my offices.

## Protect Your Ideas Take the First Step Today

If you have a useful, practical, novel idea for any new article or for an improvement on an old one, you should communicate with a competent Registered Patent Attorney AT ONCE. Every year thousands of applications for patents are filed in the U. S. Patent Office. Frequently two or more applications are made for the same or substantially the same idea (even though the inventors may live in different sections of the country and be entirely unknown to one another). In such a case, the burden of proof rests upon the last application filed. Delays of even a few days in filing the application sometimes mean the loss of a patent. So lose no time. Get in touch with me at once by mailing the coupon below.

### Prompt, Careful, Efficient Service

This large, experienced organization devotes its entire time and attention to patent and trademark cases. Our offices are directly across the street from the U. S. Patent Office. We understand the technicalities of patent law. We know the rules and requirements of the Patent Office. We can proceed in the quickest, safest and best ways in preparing an application for a patent covering your idea. Our success has been built on the strength of careful, efficient, satisfactory service to inventors and trademark owners located in every state in the Union.

### Strict Secrecy Preserved— Write Me in Confidence

All communications, sketches, drawings, etc., are held in strictest confidence in strong, steel, fire-proof files, which are accessible only to authorized members of my staff. Feel free to write me fully and frankly. It is probable that I can help you. Highest references. But **FIRST**—clip the coupon and get my free book. Do THAT right now.

### No Charge for Information on How to Proceed

The booklet shown here contains valuable information relating to patent procedure that every inventor should have. And with it I will also send you my "Record of Invention" form, on which you can sketch your idea and establish its date before a witness. Such evidence may later prove valuable to you. Simply mail the coupon and I will send you the booklet and the "Record of Invention" form, together with detailed information on how to proceed and the costs involved. Do this NOW. No need to lose a minute's time. The coupon will bring you complete information entirely without charge or obligation.

**Clarence A. O'Brien**  
Registered Patent Attorney

Member of Bar of Supreme Court of the United States; Court of Appeals, District of Columbia; Supreme Court, District of Columbia; United States Court of Claims.  
Practice confined exclusively to Patents, Trademarks, and Copyrights



**CLARENCE A. O'BRIEN**  
Registered Patent Attorney

3509 Security Savings and Comm'l Bank Bldg.,  
Washington, D. C.

— or —  
Suite 1106, Dept. K-5, Woolworth Bldg., New  
York City

Please send me your free book, "How to Obtain a Patent," and your "Record of Invention" form without any cost or obligation on my part.

Name .....

Address .....

(Important: Print or Write name clearly  
and address office nearest you)



# A-n-n-o-u-n-c-i-n-g S. Gernsback's Radio Encyclopedia

Second Edition Completely Revised

**T**HE first edition of my Radio Encyclopedia—39,000 copies—is completely sold out. The first printing of this famous **First Encyclopedia of Radio** ever published has been totally consumed. A new edition is now in preparation. It will be issued in January, 1931.

This new edition will represent not only a complete revision of all the material in the first, but much valuable new information has been added, making the new volume about twice the size of the former.

A vast amount of new material has been collected and arranged, and is incorporated in the forthcoming edition. This new data covers all the momentous innovations and improvements in radio construction and technique which have developed since the first edition came off the press.

Some of the new subjects are:

Short wave sets, circuits, coils, etc.

Receiving sets, all types; battery, A.C., D.C.; modern superheterodynes; home recording equipment.

Power supply systems; all types, including "B" eliminators and systems used in all types of A.C. and D.C. electric sets.

Television. The latest development with complete descriptions of all types of apparatus and circuits.

Sound Pictures and Public Address systems. Complete circuits and descriptions.

Transmitting systems. Both short wave and broadcast.

Testing Apparatus and Instruments. Invaluable to the radio dealer and serviceman.

Trouble Shooting in modern radio sets, thoroughly covered by text and pictures.

And last but not least there has been added a section of important tables, indispensable to the radio constructor, serviceman, professional, designer, and amateur; among these tables will be found:

Complete vacuum tube characteristics.

Tables of voltages at different sockets in modern sets.

Resistor, and values employed in voltage dividers and how they are calculated.

Coil and condenser data, showing the size of coils required with different condensers for a given wave length band.

Voltage regulators—for fluctuating line voltages.

Wavelength and frequency conversion tables.

Power consumption of standard radio sets.

Sound absorption of different materials.

Condenser replacement table.

Wire tables.

Radio set table, listing all known receivers by makes, style numbers, types of sets, tubes used.

Etc., etc.

The new Radio Encyclopedia will be a book of the same size as the first edition—9 by 12 inches—printed on heavy durable paper. The number of pages is doubled. The binding will be in semi-flexible red morocco keratol, gold stamped, with marbled fly-leaves, and the text will be printed in large easily readable type.

### SPECIAL OFFER

The price of the second edition of S. Gernsback's Radio Encyclopedia will be \$3.98 upon publication; but as an inducement to those who wish to order the book now, a special pre-publication price of \$2.98 is being offered.

This special offer will positively be withdrawn as soon as the book is issued in January 1931.

The new book will be one of the biggest values ever offered. Thousands of the purchasers of the first edition declared that they could not see how such a voluminous, elaborately printed book could be produced and sold at so low a price. The second edition will represent three times as much value. Money refunded without question if you are not satisfied!

**EVERY SUBSCRIBER TO THIS PRE-PUBLICATION OFFER WILL HAVE HIS NAME STAMPED IN GOLD ON THE COVER OF HIS BOOK, AND HIS COPY WILL ALSO BE PERSONALLY AUTOGRAPHED BY THE AUTHOR.**

Use the coupon at left. Mail it now—not only to save money, but also to make sure that you get your book from the first printing, which will be limited.

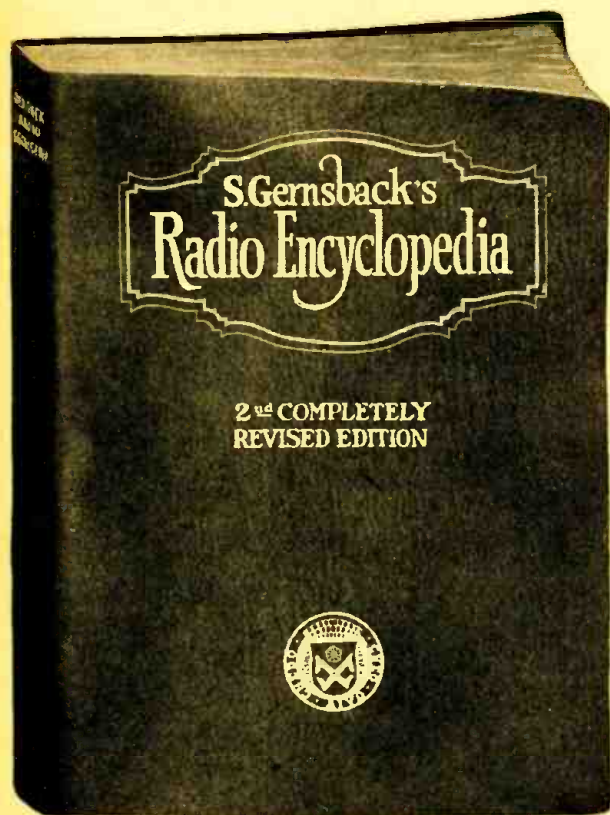

Sidney Gernsback,  
98 Park Place,  
New York City.

I enclose herewith \$2.98, for which you are to send me postpaid the completely revised and enlarged second edition of:

S. Gernsback's Radio Encyclopedia

personally autographed by you, and with my name stamped in gold on the cover as per your special pre-publication offer.

I understand that this book will be published in January, 1931, and that this special offer will no longer be available once the book is issued.

Name .....  
(To be Gold Stamped—Print exactly to avoid mistakes)

Address .....

City ..... State .....

RC-12

## Radio Timekeeper

(Continued from page 339)

is not impossible that our astronomical observations, the basis of all time corrections, are subject to equal errors from irregularities in the motion of the earth itself.

In addition, a gradual change in the running of the clocks, due to the aging of the constantly-vibrating crystal, as well as that of the tubes, may be expected; but the former correction will take considerable time to work out, as this apparatus has been but lately perfected to the degree described here.

(Further technical details will be found in the pamphlet of the Bell Telephone Laboratories, "High Precision Standard of Frequency," by W. A. Marrison—"Reprint B-402"; or in *The Proceedings of the Institute of Radio Engineers* for July, 1929.)

The natural form of quartz: 0-0' is the "optic axis." A slice cut directly through this, taking in one of the "electric axes" such as E'-E', is affected by heat one way; one cut between the centers of opposite sides, in another. The best regulators are cut at an intermediate angle, from side to side.

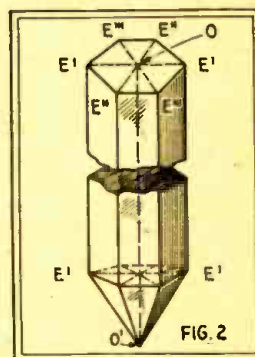

## "Stenode Radiostat"

(Continued from page 345)

where; the difference being that a channel of 30 cycles is considered sufficient to carry a high-speed code message. The several messages are modulated through a special transformer, with multiple primaries and a single secondary, from which they are put on the line. At the receiving end

group of amplifiers are connected in parallel; each connecting to a magnetic coil opposite an armature which is fixed to a tuning fork. The fork is mechanically tuned to the received frequencies, and carries on the opposite arm a second armature; which moves in the field of a coil connected through an amplifier to the automatic recorder of messages. The result is that the only signals transmitted through the fork are those of the frequency to which it is tuned. Successful reception, it is stated, is obtained on a group of frequency bands which actually overlap each other twenty cycles.

### IS THE STENODE PRACTICAL?

Editor, RADIO-CRAFT:

It was with much interest that I read the article on the Stenode method of transmission and reception. I recalled having read an article in an English publication, last winter, questioning the verity of the sideband theory; the basis of the writer's argument being Dr. Robinson's invention. So it was with renewed and increased interest that I read the article in your September issue.



Personally, I think the Stenode is very impractical, particularly in its present state, and destined to oblivion. I am not a hard-shelled reactionary, but my reasons are very obvious.

The tuning of the receiver would be very arduous, to say the least; since the fundamental frequency must be supplied at the receiving end. Considering the complexities of today's frequency control at the transmitting end, imagine the tuning problems involved.

The crystal's cost and replacement would be prohibitive, considering the precision fitting necessary. The only alternative is to build the intermediate frequency around the individual crystals, which would be even more expensive.

The mechanical modulator of the transmitter would, more likely than not, be very sluggish in action, particularly on the higher frequencies, because of the inertia and physical limitations of the crystal plate.

Modulation of the oscillator of a transmitter is anything but conducive to frequency stability in any transmitter—and this is the thing needed to insure success with the Stenode system.

The output of a modulated (or unmodulated) oscillator is very small, because of the very small voltages which must be applied to avoid damage to the crystal. Therefore, the output must be built up through a cascade of linear amplifiers—which would be a pretty expensive proposition, especially for the medium-priced broadcaster of limited means.

The output of a ordinary modulated amplifier, running under normal load, is the rated output of the tube or tubes unmodulated, with a peak output with 100 per cent. modulation four times as great. The linear amplifier must, to avoid distortion, be run at one-quarter of its normal output, with a peak power equal only to its normal unmodulated output. In other words, a transmitter now rated at one kilowatt would have to use four times that power to obtain the same output with linear amplifiers. That means not only larger output tubes, but a much larger power supply; the cost of which is nothing to laugh at.

Finally, as Mr. Fitch's article said, it doesn't in any way refute the sideband theory; it merely serves to suppress sidebands at the receiving end. Of course, it provides fertile ground for the experimenter, although it is pretty expensive; and we may yet derive some good from it.

ELMER L. SMITH,  
131 Claremont Ave.,  
Montclair, N. J.

(Our correspondent's criticisms are interesting, indeed, and we fully agree with him that the Stenode system is complicated and still a laboratory experiment—but not quite so complex as he has pictured.

In the first place, only one quartz crystal is employed at the receiving end, and this need not be ground to any accurate degree. The intermediate amplifier can be tuned to suit it, by a simple turn of a condenser shaft. And the main tuning and oscillator controls require only a little more precision than those of an ordinary superheterodyne. The mechanical frequency-modulator for the transmitter, shown in connection with the article was diagrammatic only, to illustrate

**Small in  
SIZE**

**Super-  
TONATROL**

**Large in  
PERFORMANCE**

Licensed under U. S. Pats. 1,773,105 and Pats. Pend. and Canadian Pats. 281,173 and 286,778.

# SILENT - DURABLE

## The BETTER Volume Control For All Replacement Purposes

For quiet, smooth control of radio volume, experts agree that there is no substitute for the Super-TONATROL.

Dissipates a full 5-watts. And tests prove it will outlast the useful life of any radio set. New type resistance element permanently fused to vitreous enameled steel plate. Pure silver floating contact. Stepless variation. Metal cover aids rapid heat dissipation. 7 types for all usual radio requirements. Write for special folder describing types and recommended uses.

## Better Resistors and Voltage Controls For Every Radio Requirement

Electrad manufactures a complete line of resistors and voltage controls for every radio and power supply requirement, including television. Correct engineering principles and rigid supervised manufacturing stand behind each Electrad product—your assurance of highest quality. Choose Electrad and be certain of PERFORMANCE.

(Specialists in Loftin-White Direct Coupled Amplifiers. Three models, with '45, '50 and '50 push pull output. Mail coupon for data.)

# ELECTRAD

INC.

ELECTRAD, INC., Dept. RC-12,  
175 Varick St., New York.

Please send Super-TONATROL Folder.  Check here for circular covering all Electrad Products.  Check here for Loftin-White Data.

Name .....  
Address .....

### Short-Wave Receiver

Build a Real Set for \$10; operates Speaker; Music Direct from enormous distances. Get 6 sheets of Instructions; Parts List, Circuits, Dimensions, Layout, Assembly Prints, Coil Data, Operation, How to Build it Gradually; More dope than \$5 worth of magazines. Complete, 65 cents.

**BUILD LATEST TRANSMITTER FOR \$8:** Instructions (8 sheets) gives data as for above set; also Aerial sizes, Rectifiers, Filters, A.C. or batteries; Start Sending with Receiving Tube; then add big tube. Ham license easy after building it; Complete, 60 cents. Dollar bill brings both Instructions.

**DELFT RADIO**  
524 Fairbanks Ave. - Oakland, Calif.

Read the announcement, on page 364 of this issue, about the National Radio Service Men's Association.

1 and 2 Watts  
Cartridge Type

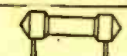
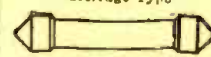

1/2  
and  
2  
Watts  
Pig-  
tail  
Type



Precision Wire Wound

Standardize on



**RESISTORS**

New low prices—new liberal discounts. More value for less money. Greater safety factors. Accuracy in construction and ratings. Give your customer the BEST at less cost. GUARANTEED.

**JOBBERS - DEALERS - SERVICE MEN**

Send for new illustrated, descriptive catalog "C."

**LYNCH MFG. CO., Inc.**  
1775 Broadway, N. Y. C.



# THE RADIO EXPERIMENTER'S MAGAZINE



Contains more material than a \$2.50 book, yet the price is but 50c. a copy.

On All Large News-stands

Big Magazine Size: 9 by 12 inches, printed on a heavy grade of book paper, with a beautiful cover in four colors—that's SHORT WAVE CRAFT.

the point, and need not be considered as the best method. There are other forms of frequency modulation which require no mechanical moving parts.

As to the percentage of modulation, this is a point not definitely settled. One hundred per cent. frequency modulation would be that degree of modulation which swings the frequency half-way across the characteristic curve of the receiving crystal—say 50 cycles. And 50 cycles is a small percentage of the total frequency of the transmitted wave. To prevent shattering the crystal, a protective vacuum tube, limiting the voltage applied to the crystal to a predetermined amount, may be used; but we do not believe that Dr. Robinson found any such scheme necessary.

It will interest our correspondent to know that recent developments in the Stenode system make it more practical by using a much wider band—up to half the present station separation, or nearly 5,000 cycles. This may be going to the other extreme and be little improvement; but a band, say, 1,000 cycles wide would allow ten times as many stations on the air, without the limitations of the 50-cycle band Stenode system.

Now a Stenode system, using a 1,000-cycle band, of course cannot employ the highly selective quartz crystal "gate." Some other system must be used for the desired selectivity. Special hand-pass selectors have been proposed, which serve the purpose and are entirely practical. The only requirement is that we change our frequency-modulated transmitter to suit.

Furthermore, a quartz crystal is not absolutely necessary when using a much narrower band. An iron bar, working under the principle of *magnetostriction*, may be employed with no danger of breaking. It is quite possible that the radio receivers of the future will work on some such system; but a few years must pass before they will reach a stage of commercial development comparable to our present systems.—C. J. Fitch.)

## Hints to Manufacturers

(Continued from page 345)

this purpose, discourages customers from buying.

Since receivers are becoming more and more sensitive yearly, and the superheterodyne is regaining favor fast, radio manufacturers should be advised to consider:

- (1) Inclusion of a loop or screen antenna inside the cabinet; or
- (2) Mounting pin-jacks, permitting loop or screen to be plugged in to first R.F. circuit; or
- (3) Provision for a small D.P.D.T. switch, at rear of cabinet, for choice of outside antenna or loop connection.

FRANK DE MARCO,  
803 Oak St., Yonkers, N. Y.

### FUSE THE SOPRANI!

THE face that stopped a clock has not yet been televised: but the voice that stopped a broadcast station has been heard in Australia, according to dispatches which say that a transmitting tube of station 3LO, Melbourne, was burnt out recently by the scream of the heroine in a radio melodrama.

SHORT WAVE CRAFT, Mr. Hugo Gernsback's latest radio magazine, has been called his greatest achievement in radio magazine publishing. SHORT WAVE CRAFT is the one and only real big magazine on short waves you have wished for so long. HERE IS PROOF!

### PARTIAL CONTENTS In Short-Wave Craft No. 4 December-January Issue

- Looking Ahead With Short Waves, by Dr. Alfred N. Goldsmith, Ph.D.
  - A New Use for Amateur Radio, by Hugo Gernsback
  - How to Convert Broadcast Receivers for Short Wave Reception, Using the Superheterodyne Principle, by Clyde A. Randon
  - Propagation of Radio Waves by Dr. J. Fuchs
  - A 19 Tube Trans-Oceanic Receiver, by Dr. Fritz Noack
  - Possibilities and Experiments in Television Transmission for Amateurs, by C. H. W. Nason
  - How to Build an S5 Meter Phone Transmitter, by R. Wm. Tanner, W8AD
  - The New Kennedy Combination Short and Long Wave Receiver, with Hook-up Diagram.
  - My Favorite Audio Amplifier for Short Wave Sets, by Mander Barnett
  - Low-Powered Oscillators, Amplifiers and Crystal Controls, by A. Binnewerk, Jr.
  - A Rolls-Royce Short Wave Receiver—Suitable for Television Reception, by C. Sterling Gleason the Hams!
  - "Among the Hams"—Photos of Short Wave Amateur Stations and Letters from Leading "Hams."
- Besides these outstanding features, SHORT WAVE CRAFT No. 4 is chock full of how-to-make-it and constructional articles on Short Wave Transmitters and Receivers, both for code and phone.

The question and answer box is ably edited by R. Wm. Tanner, W8AD, well-known writer and short wave expert.

Short Wave Receivers—Construction data for all types and kinds  
The Short Wave Experimenter  
The Short Wave Beginner  
Television on Short Waves  
Short Waves for the Broadcast Listener  
Ultra Short Waves  
Aircraft Short Wave Sets  
How to Build Short Wave Aerials  
Short Wave Question Box

Unlike other magazines, it does not contain purely technical matter of interest only to the advanced amateur and ham. Quite to the contrary, SHORT WAVE CRAFT contains a tremendous wealth of short wave material of interest to everyone who wishes to get into short wave activities.

OVER 250 ILLUSTRATIONS, HOOKUPS, CHARTS, CIRCUIT DIAGRAMS, DOZENS OF ACTUAL PHOTOGRAPHS OF RECEIVERS, TRANSMITTERS, AND A WEALTH OF PRACTICAL STUFF.

Filled to the top with real meat—not a picture book, no mathematics, no theories that are over your head, but rather practical dope, live "meat." That's what SHORT WAVE CRAFT offers you in every issue.

Regular Departments in SHORT WAVE CRAFT

Photographic Section—pictures of latest short wave sets and stations  
Transmitters for Short Waves—How to build them

PUBLISHED ON THE 15th OF EVERY OTHER MONTH

Extra Special Offer Void  
After December 15th

The regular subscription price to SHORT WAVE CRAFT is \$3.00 a year. But up to December 15th, we will accept \$1.80 for a full year's subscription (Canada and foreign, \$2.00) AND IN ADDITION will send you FREE the first two issues of SHORT WAVE CRAFT! This will give you in reality a subscription of one year and three months, value \$4.00, for \$1.80!

MAIL COUPON TODAY!

SHORT WAVE CRAFT HC-12  
96-08 Park Place, New York, N. Y.

As per your special offer I enclose \$1.80, for which, please enter my subscription for one year to SHORT WAVE CRAFT and send me also the first two issues gratis.

NAME .....

ADDRESS .....

CITY .....

STATE .....



# New Radio Devices for Shop and Home

(Continued from page 344)

The device is an addition to the well-known and extensive line of radio controls and instruments made by the Clarostat Mfg. Co. of Brooklyn, N. Y.



Dial of the attachable tone control.

## LINE-VOLTAGE REGULATORS AND THEIR USE

AFTER long and careful research into the performance of radio tubes, under the influence of so-called automatic line-voltage regulators, Albert G. Bill, of the engineering staff of the Van Horne Tube Company, Franklin, Ohio, has arrived at certain definite conclusions; which he reports for the benefit of radio jobbers, dealers, Service Men, and others interested in this phase of radio:

"The use of line-voltage regulators, to provide the usual socket-power radio with a correct and uniform operating voltage, and their relative merit for the satisfactory operation of radio tubes, has been a topic of discussion since the advent of the all-electric radio.

"Judging from the survey of the R.M.A., it is obvious that a wide range of line-voltages prevails; especially in the larger cities, where the industrial demand is somewhat irregular.

"In the following discussion, the design and problems involved in the use of regulators will be adhered to.

"These devices usually consist of resistance wire enclosed in a perforated case, fitted with a contact plug and receptacle, the resistance element of which is usually referred to as an automatic ballast resistor; offering high resistance to high voltages, and low resistance to normal and sub-normal conditions; thereby maintaining constant the input to the set."

(This description does not apply to the control devices known as "ballast tubes."—EDITOR.)

"However, tests have been made which prove that in most cases the resistance values remain constant.

"Their use when the line-voltage is normal, or sub-normal, is detrimental; as the required voltage would not be available to the set, resulting in low electronic emission from the filament or, in the case of the 227 and 224, from the cathode. Their use should be limited to high line conditions only.

"In cooperation with tube manufacturers, leading set manufacturers usually design the primary of their power-supply transformers so that the filament voltage to the set does not exceed the maximum and minimum rat-

ing of the tubes, for a corresponding change in line-voltage.

"It is therefore obvious that deviation of 5 to 10 volts from the rated line voltage will not result in serious filament or heater voltages."

(A 5- to 10-volt variation in line-voltage is, however, only a fraction of that encountered in many parts of the country.—EDITOR.)

"Hence," Mr. Bill concludes, "line-voltage regulators have a limited application for the satisfactory operation of radio tubes and sets, and should be used only in cases of high line-voltage."

(It might be better to designate appliances of the type described as line-voltage "reducers," instead of "regulators." They serve a very useful purpose, when properly applied.—EDITOR.)

## PROGRAM-RUNNING IN ENGLAND

OUR British cousins derive considerable amusement from reading about running in America; even though His Majesty's Excise had some trouble with brandy-smugglers in the days of Gauger Robert Burns. However, radio-program smuggling seems to be an institution over there.

Broadcasting in Great Britain is monopolized by the British Broadcasting Co., a quasi-governmental institution, with the firm resolve to give the British public what will be good for them intellectually and morally. While the aforesaid B. p. writes letters of complaint to the radio magazines and, we presume, the *London Times*, the B. B. C. steers its course serenely.

Of course, there is no radio advertising in England. The set owner pays his license at the postoffice; and the P. O. hands the receipts over to the B. B. C., after deducting its commission. No one can rent "time on the air."

However, the Channel separating England from France is no wider than the range of a good swimmer; and France has several fairly-powerful radio stations which are willing to turn an honest guinea or two (one guinea equals 130 francs 42 centimes).

The result is that the Englishman who finds the Sunday afternoon programs of the B. B. C. deadly dull is confronted by advertising inviting him to "Turn the Dial to Radio-Paris," and hear the latest phonograph records.

And, just to close this bit of international comity on the right note, this competing advertising is carried in the program magazine published by the B. B. C!

## RADIO LITERATURE

THE CARE AND USE OF MICROPHONES, by E. E. Griffin. Paper cover, 8 pp. 3½ x 5½. Published by the Universal Microphone Co., Inglewood, Cal. Price 10 cents.

This little booklet is intended to instruct those who use microphones with radio receivers or amplifiers, sound systems, etc.—a practice becoming more general daily—in the details which are necessary for their use, and which it would be costly to learn by experience with these sensitive instruments. Some simple hookups are shown; and practical advice as to their use is given. The booklet is well supplemented by the catalog of the publishers, which is also informative.

# The Latest Data!

Complete and up-to-date information covering the entire field of Radio—all arranged for ready reference in this one big guide book

**BYRD'S ANTARCTIC RADIO EQUIPMENT**—Receivers, transmitters and latest navigation aids used on this epochal flight fully described.

**TELEVISION**—Mr. C. F. Jenkins, father of television and radio movies, gives you in his own words complete directions for building practical television equipment.

**INTERFERENCE ELIMINATION**—New methods systematically outlined by W. F. Fleming, radio engineer.

**RADIO AUTO-ALARM**—Description of new device for ships which keeps the SOS watch while operator is off duty.

**SHORT-WAVE APPARATUS**—Commercial and amateur, described and illustrated.

**NEW BROADCASTING EQUIPMENT**—Temperature-controlled Piezo crystal oscillator; 100 per cent. modulation panel and other new apparatus.

—and these are only a few of the NEW subjects added to the most complete radio handbook ever published—

# THE RADIO MANUAL

A Handbook for Students, Amateurs, Operators and Inspectors



Here's the answer to every question about the principles, operation, and maintenance of apparatus for radio transmitting and receiving. Important new chapters have been added to bring it right up to the minute. Many new photographs and diagrams have been included. It is now more than ever the one complete handbook covering the entire radio field.

A Complete Course in Radio Operation in ONE VOLUME

Prepares for Government License

20 big chapters cover: Elementary Electricity and Magnetism; Motors and Generators; Storage Batteries and Charging Circuits; The Vacuum Tube; Circuits Employed in Vacuum Tube Transmitters; Modulating Systems and 100 Per Cent. Modulation; Wave-Meters; Piezo-Electric Oscillators; Wave Traps; Marine Vacuum Tube Transmitters; Radio Broadcasting Equipment; Arc Transmitters; Spark Transmitters; Commercial Radio Receivers; Marconi Auto-Alarm; Radio Beacons and Direction Finders; Aircraft Radio Equipment; Practical Television and Radio Movies; Eliminating Radio Interference; Radio Laws and Regulations; Handling and Abstracting Traffic.

Prepared by Official Examining Officer

The author, G. E. Sterling, is Radio Inspector and Examining Officer, Radio Division, U. S. Dept. of Commerce. The book has been edited in detail by Robert S. Kruse, for five years Technical Editor of QST, the Magazine of the American Radio Relay League, now Radio Consultant. Many other experts assisted them.

Examine it FREE!

The latest edition of "The Radio Manual" is now ready. Nearly 800 pages; 369 illustrations; bound in flexible Fabrikoid. The coupon brings the volume for free examination. Within 10 days you may return the volume or send the price of \$6.00.

MAIL THIS COUPON

D. Van Nostrand Co., Inc., 250 Fourth Ave., New York. Send me the Revised Edition of THE RADIO MANUAL, for examination. Within ten days after receipt I will either return the volume or send you \$6.00, the price in full. (R.C. 12-30) Name \_\_\_\_\_ Street and No. \_\_\_\_\_ City and State \_\_\_\_\_ Business connection \_\_\_\_\_



# Ten Tools In One

**\$1.00**

A small but handy article which serves for every possible need of the all-round mechanic. Invaluable in any emergency.

An excellent combination of utilities for the household—every necessity featured: hammer, knife-sharpener, nail-puller, bottle-opener, screw-driver, can-opener, cork-screw and weigh-scale. Just glance at the illustration and you will see how really useful this article is. Only 10 in. high. Indispensable to autoists, campers, Boy Scouts, canoeists, picknickers, etc.

Price \$1.00 Postage Paid. Be the first one in your town to own the "Ten Tools in One." Send coupon with your name, address, city and state with one dollar.

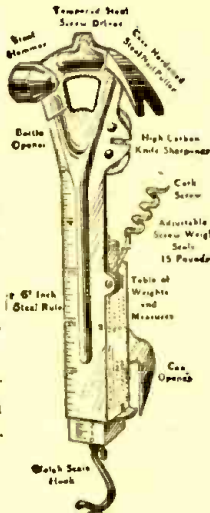

SEND FOR YOURS

T  
O  
D  
A  
Y

MAIL COUPON

NOW!

Grenpark Tool Company, 245 Greenwich Street, New York, N. Y. RC-12

Enclosed find \$1.00 for which please send me prepaid your "Ten Tools in One."

Name .....

Address .....

City..... State.....

## Prepare for BIG PAY JOBS! Learn Radio and Television

Organized Labor—owner of Station WCFL, Chicago, the first station to broadcast television on an aural wavelength—is conducting a nation-wide good-will campaign and suggests the study of Radio and Television as a happy and profitable way of getting better acquainted, and makes this astounding offer:

Complete Radio and Television Course ALL FOR  
Handy Loose-leaf Lesson Folder \$2  
Radio and Television Dictionary ONLY  
Large Schematic of Federation Four  
WCFL Radio Magazine for One Year

The WCFL Radio and Television Course is used as standard text in 400 high schools and is being studied by nearly 60,000 adults. It has helped thousands to increase their earnings.

OPENS THE DOOR OF GREATER OPPORTUNITY IN RADIO FIELD.

WCFL, 623 South Wabash Ave., Chicago.

For the attached \$2 enroll me for the WCFL Radio and Television Course, also send me Loose-leaf Lesson Binder, Radio and Television Dictionary, Large Schematic of Federation Four and WCFL Radio Magazine for one year.

Name .....

Street .....

Postoffice..... State.....

Beware of Air Monopoly

WCFL Radio Magazine is the only publication fighting for the freedom of the air—the gravest question now before the public. Whoever monopolizes broadcasting will dominate the Nation. The air MUST remain FREE.

### Become a Reporter!

Thousands of opportunities for young men to enter the Newspaper field. Fascinating work. You will meet interesting people; interview celebrities. A famous New York reporter with twenty years of practical experience has written a whole course of journalism and reporting in six easy lessons. He shows you the short-cut to success. He tells you what to do and what not to do, to become a successful reporter. Send today for the "PRACTICAL COURSE IN JOURNALISM," by Henry John Brockmeyer of *The New York Evening Post*. Just drop us a Postal Card—no need to send money. We will mail you the whole set of six books and you pay the Postman \$3.00 plus a few cents for postage. No more to pay. Money absolutely refunded if not satisfied.

P R E S S G U I L D

16-E Murray Street Dept. D-1230 New York

### QUIT TOBACCO

No man or woman can escape the harmful effects of tobacco. Don't try to banish unaided the hold tobacco has upon you. Join the thousands of inveterate tobacco users that have found it easy to quit with the aid of the Keeley Treatment.

**KEELEY** Treatment For Tobacco Habit Successful For Over 50 Years

Quickly banishes all craving for tobacco. Write today for Free Book telling how to quickly Free yourself from the tobacco habit and our Money Back Guarantee.

THE KEELEY INSTITUTE  
Dept. L-708 Dwight, Illinois

## S.-W. Experimenters

(Continued from page 353)

excellent stability of this receiver's operation, is of a type not available in the United States. It is wound in a wide-slotted form, two inches long and an inch and a quarter in diameter, with 300 or 400 turns of No. 30 wire, 100 in each slot. The feature of this choke is that through the center, in a space less than half an inch in diameter, there are placed 50 fine strips of silicon steel, such as are used for transformers.

With this receiver, I have heard Schenectady, Pittsburgh, Cincinnati, Oakland, Chicago, New York and other short-wave stations in the United States, and PCJ, Holland; as well as HRB, Tegucigalpa, Honduras; NRH, Heredia, Costa Rica; and HKC, Bogota, Colombia. I use a 60-foot single-wire aerial. The clarity, volume and freedom from static is very great on the short waves which I have mentioned.

I trust that this circuit will be of interest to other experimenters.

M. J. ALTAMIRANO,  
La Union, El Salvador,  
Central America.

(The use of the iron-cored choke on longer waves has been less common in recent years; but it has not hitherto been incorporated in receivers for such short waves, so far as we know. At first thought, it might be supposed that the high inductance would defeat itself, by permitting the signal to pass through the self-capacity of the choke; but engineers find that the effect of iron at very high frequencies seems to be less pronounced. We are unable to see how fading effects can be prevented in any circuit, except those which compensate them by an automatic volume control; but undoubtedly experimenters will find something of interest in Señor Altamirano's results.—*Editor.*)

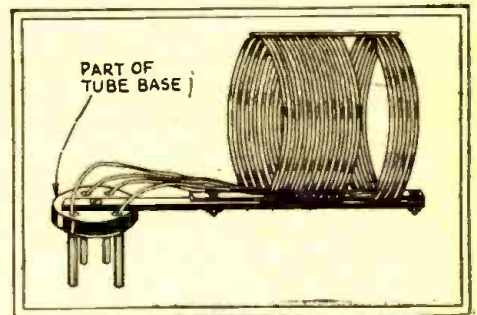

Fig. 2

A plug-in coil, made this way, requires only a tube socket for connections; it is best to bolt a handling ring to the base.

### A SIMPLE COIL MOUNTING

Editor, RADIO-CRAFT:

In constructing the triple-tuned R.F. short-wave receiver described by Mr. Clayton in the June issue of RADIO-CRAFT, I encountered the problem of mounting modern low-loss coils. I have not as yet seen published in your magazine any description of a mounting of this type for a coil; so I am sending in a sketch of the method I employed. By sawing the top from a tube base, and drilling a hole in the center, the coils may be mounted as shown. A pull-out

On Page 324 you will find an interesting announcement of the RADIO SERVICE MAN'S HANDYBOOK with addenda data sheets. It takes but a few minutes to read of the full particulars about this new book.



ring may also be fastened to the tube base, for convenience in handling the coils. The parts required, besides the tube base and the coil, are two strips of bakelite of the proper length and three machine screws, with nuts.

W. R. ARGENTA,  
Warwood, Wheeling, W. Va.

**BETTER REGENERATION CONTROL**

Editor, RADIO-CRAFT:

In experimenting with short-wave receivers, I have found that a shunt vernier regeneration control works very nicely, and I thought you might wish to publish it for the benefit of fans. Your magazine is absolutely top-notch, and no other similar publication is to be compared with it.

I refer to the use of a midget condenser,

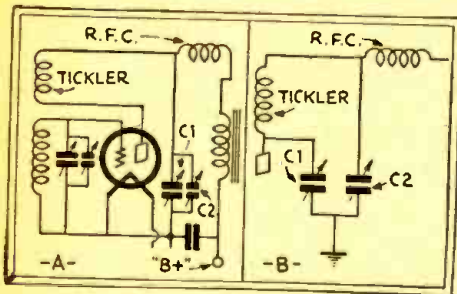

Fig. 3

A shunt condenser, of small capacity, with a large dial, for C1, gives a better control. An interesting variation—with a very small capacity—might be that shown at B. The tickler must be sufficiently large.

across the regular regeneration condenser, and mounted in a convenient place on the control panel. The advantages are apparent in the control of weak signals.

E. E. KANOUSE,  
Shelbyville, Indiana.

(The method known is quite familiar to most amateurs, we think; but, exactly as a "tank condenser" is used in tuning with a small condenser in shunt, so very fine control of regeneration may be obtained in the same way. A very fine adjustment of capacity, also, may be obtained by using a large condenser in series with a small one, as explained in a previous issue of RADIO-CRAFT.)

**ANOTHER ONE-TUBE SHORT-WAVER**

Editor, RADIO-CRAFT:

In the July issue, you published an unusual hook-up of mine. I have made another which is out of the ordinary, as you

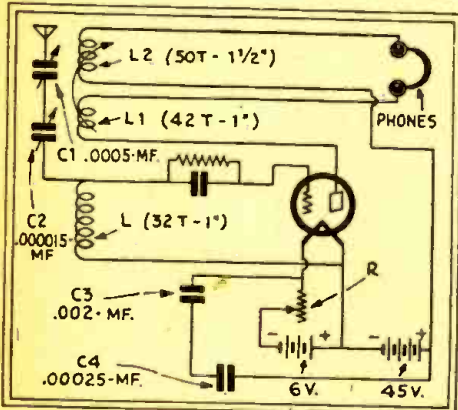

Fig. 4

Mr. Luebbers specializes in odd one-tube circuits. Here is another.

will see. It has a double tickler; the experimenter can use plug-in coils, but the results won't be as good. With this I received W2XAF at speaker volume on phones! It super-regenerates, but I believe the volume is obtained by the double ticklers. I do not know in what way the volume is increased by the use of the two coils; but I do not believe that louder volume can be obtained on a single tube. I use a 100-foot antenna, and grounding the end gives better results. (When the length of the received wave is less than four times that of the aerial, the signal is not shorted by grounding the far end of the latter. A hundred feet is 30.5 meters.—Editor.)

The parts used and their values are: C1, .0005-mf.; C2, Pilot 5-plate midget; L, 32 turns on a 1-inch form (I used a broomstick); L1, 42 turns on the same diameter; L2, "amplifier coil," 50 turns on 1 1/2-inch form—all three are No. 18 wire.

C3 is .002-mf., and C4 is .00025; R is set at 22 ohms, and the grid leak should not be higher than 3 megs. (lower values should be used for experiment). Good headphones, a standard tube socket and an '01A or '00A tube, with batteries, complete the equipment. Only 45 volts is needed.

By adjusting the coupling of L1 and L2, volume is controlled. All code stations, especially WKJ, come in with great volume.

MATT LUEBBERS,  
3950 Page Boulevard,  
St. Louis, Mo.

(While this circuit apparently permits extraordinarily close tuning of the signal—in this case the larger condenser, C1, is actually a "vernier" for the smaller, C2—it is probable that Mr. Luebbers is favored with an unusually good location. We do not think it possible to guarantee results with this circuit.—Editor.)

**ULTRA-SHORT WAVES FOR RELAYS**

EUROPEAN transmitters seem to encounter more trouble than Americans, in arranging wire-line relays for broadcasting. In France, the state authorities controlling the telephone appear to look with disapproval on its use for this purpose; and in Vienna, it is stated, the large broadcast station "Ravag" has worked out a plan for 3-meter relays to the transmitter from the point where an outside program is picked up. This, it is calculated, will save time and expense; and the ultra-short waves have a sufficient working radius to cover local events. The 3-meter transmitter, because of its very short wavelength, is of very compact physical dimensions and readily portable; and the short aerial required presents no difficulty in its erection. In addition to this, the modulation is not affected in radio transmission on ultra-high frequencies; as would be the case with any but a specially engineered wire line.

**ESPERANTO BROADCASTS**

ESPERANTISTS have occasional programs from some European broadcast stations, particularly in or near small countries whose languages are not spoken outside their own borders. In addition to this, it is announced that one short-wave transmitter has been devoted to work in this tongue. It is VK3CA, of Vera Street, Williamstown 1, Melbourne, Australia.



**Dr. T. O'CONOR SLOANE**  
**Will Teach You at Home!**

ANYONE WHO CAN READ AND WRITE can study Chemistry through our simply prepared course. You don't need a higher education, and you don't need any previous experience or preparation. Chemistry is not harder to understand than electricity or radio. Just plain sense and ordinary observation powers.

**Laboratory Outfit Free**

THE COMPLETE CHEMICAL OUTFIT AND APPARATUS supplied to you as part of your Course, without extra charge, makes you the owner of a laboratory, containing all the materials and instruments used by a full-fledged chemist. This working kit, which is shipped to you at the outset of the course, becomes your permanent property. It is a sturdy fitted wooden cabinet containing over 100 pieces of laboratory apparatus and chemical supplies.

**We Can Teach You At Home**

Our faculty knows just how to mold you into a skillful laboratory worker. THE HEAD OF OUR STAFF IS DR. T. O'CONOR SLOANE, scientist, engineer and author of wide repute. He has had more than fifty years of teaching experience. Our course fits you for an immediate position in a chemical laboratory, and you do not have to give up what you are doing now to learn it. During evenings and week-ends you can work at home on the fascinating experiments and the delightfully simple but comprehensive lessons.

**Big Money in Chemistry**

CHEMISTS ARE WELL PAID MEN. Not only will our training help you to get a better job, but a worthwhile start on a new level. You can patent the work of your hands and your brain, and perhaps make millions of dollars on a new chemical discovery. Every day the newspapers and magazines are full of new items reporting new chemical discoveries—in mining, in electricity, in foodstuffs, in sanitary and medicinal appliances, in paper-making, rubber, steel, iron, dyestuffs, textiles, in fact in every well known industry—and behind each of these discoveries stands a well-trained chemist who knew how to take advantage of opportunity!

**No Exaggerated Claims**

THE INSTITUTE DOES NOT CLAIM that every chemist makes millions, nor do we guarantee that you will immediately get a job paying \$10,000 a year. But many have done it and there is no reason why you can not do it too. Often enough you read or hear about men who have found the highest recognition, from small, inconspicuous beginnings, and you wonder how they got the "lucky break." Why, you wonder yearningly, couldn't you be such a "lucky" fellow? You can be—but you have to meet luck half way.

**Get Started Today!**

IF YOU WOULD LIKE TO KNOW MORE ABOUT CHEMISTRY, and if you are sincere in your desire to get out of the treadmill of job anxiety and wage dependence, if you have ambition enough to want to become a chemist, and perhaps a famous one some day, you will not wait until tomorrow to find out how to go about it. MAIL the coupon below today. There is no charge and no further obligation. You will be simply asking us to write you about something that you want to know.

Chemical Institute of New York, Inc.  
Dept. RC-1230  
19 Park Place, New York, N. Y.

Please send me at once, without any obligation on my part, your Free Book "Opportunities for Chemists," and full particulars about the Experimental Equipment given to every student.

NAME .....

ADDRESS .....

CITY..... STATE.....



# Hotel Directory of the Radio Trade

The hotels on this and the following pages are patronized by the Radio Trade. Make them your headquarters.



**\$3.00**  
Per Day  
and Up

**800**  
Rooms  
800 Baths

*Old Fashioned Hospitality  
in a Modern Setting*

In the Grand Central Section, 10 minutes from Penn. Station, near Times Square, Fifth Avenue shops and important commercial centres and theatres.

*Radio in Every Room*

Single Rooms \$3 to \$5 per day  
Double Rooms \$4 to \$6 per day

S. Gregory Taylor, *President*    Oscar W. Richards, *Manager*

**HOTEL MONTCLAIR**  
49<sup>TH</sup> TO 50<sup>TH</sup> STS.  
AND LEXINGTON AVE.  
**NEW YORK CITY**

## Short-Wave Notes

SAIGON, Indo-China, is well known to short-wave listeners by reason of its radio-telephone service to Paris and, more lately, a high-power broadcast station, which was inaugurated on July 18 with a program transmitted from Paris, under the auspices of the French government.

The violence of static in tropical countries has led to the selection of short wavelengths for even local broadcast stations, notwithstanding the difficulty occasioned by the skip-distance for reception outside the local area. The Saigon transmitter was therefore designed for work between 40 and 90 meters, to give it a greater service area than would be available on shorter waves; and transmissions were begun on 49 meters. The station is of 10 kilowatts power, and has been heard plainly in the United States.

PHI, one of the world's best-known short-wave broadcasters, has discontinued this work because of the troubles (political and religious in their nature, it is hinted) which are at the present time affecting Dutch broadcasting. A general chorus of protests from listeners all over the world was the response to this announcement.

PCJ, the old standby of American short-wave listeners, has installed new aerial equipment, and is conducting tests to determine the relative efficiency of the older and newer antennas. On Wednesdays from 11 a.m. to 3 p.m., and on Thursdays and Fridays from 1 to 3, these are used alternately for half-hour periods; and reports from distant listeners, as to relative signal strengths, are solicited.

Belgrade, Yugoslavia, is working on 30 meters from 3 to 4 p.m. Mondays.

The success of the programs from G5SW, Chelmsford, England, in reaching British colonies with programs from London has led to an increasing demand for "Empire programs"; and it is planned by the British government to expend over \$100,000 in making this service more extensive during the coming year. A special transmitter will be erected.

Among the latest extensions of radiophone service were a conversation between passengers on the German liner *Cap Arcona*, outward bound in the North Sea, and others on an express train between Berlin and Hamburg. The reception from the steamship's transmitter was put on land lines at Cuxhaven, Germany, and from there the message went through the long-distance telephone service until it was put on "wired radio" lines paralleling the railroad tracks; whence it was picked up by a receiver aboard the train.

Another world-spanning conversation, over commercial lines, was put through from New York to Sydney, Australia, by the lines of the A. T. & T. and the British and Australian postoffices. The first radio relay was from Lawrenceville, N. J., to Baldoek, England; and after the message had passed through the London postoffice central, it was put on the beam transmitter at Rugby. The distance covered exceeds 15,000 miles, over this route. At the Australian end the message was finally put on a loud speaker, in the banquet room of a hotel.

*Chicago's Newest Hotels*



*The St. Clair*  
500 Rooms—\$2.50 up

**Hotel**

**Eastgate**

Ontario Street, one block East of Michigan  
*Excellent cuisine, and service perfect to the smallest detail*  
*Just a Step from the Loop*

**St. Clair  
Hotel**

Ohio and St. Clair Streets  
Telephone: Superior 4660  
Beautiful Dining Room - Coffee Shop -  
Service Ultra Mode

**FREE  
GARAGE**  
NO INCREASE  
IN RATES

Free Garage to tourists



*The Eastgate*  
300 Rooms—\$2.50 up



The German police, says a recent press dispatch, have been asked by the American authorities to locate a short-wave receiver used to pick up transatlantic messages for the purpose of obtaining information for use on the stock exchanges. It may be remarked here, again, that radio business is by statutes, if not by electrical laws, protected against eavesdropping; and that it is unlawful to use any private information obtained from any message for the benefit of the unauthorized receiver or his associates. While long-distance telephone messages are heard by many listeners, it is seldom indeed that anything of a business nature would be understood by the ordinary fan; but even an unlicensed listener is allowed to divulge only matter which is broadcast, or directed (as in tests) to the listening fraternity.

Amateurs in Germany, it is announced, can no longer work singly. To reduce the number of transmitters, and relieve the wavebands of jamming, licenses will be granted only to clubs or associations.

The "WAC" is well known to transmitting "hams" as signifying "Worked All Continents." This is a little more difficult, now that Antarctica has been left to the penguins; but five continents are usually enough. However, not to be outdone, the British radio society now issues a "WBE" certificate to those who have established two-way communication with a British transmitter in each continent. The letters, it will be seen, stand for "Worked British Empire."

### Television News

(Continued from page 349)

stations, as well as the technical staff of the Commission, will be pleased to have reports from experimenters. Interference, in television, may be expected to produce geometrical black patterns in the background of a received image, if it is due to a regular transmission interfering with the desired station. This would distinguish it from other forms of local interference.

The Columbia Broadcasting Co. has applied for a license for a 5000-watt transmitter for its New York studio. Proposed transmissions will be 60-line, 72 units wide, 20-frame, like those of the N. B. C.

### POWER RATING OF EUROPEAN STATIONS TO BE LOWERED

AFTER much debate, a method of rating broadcast transmitters by the power actually radiated from the aerial has been set up as the international standard in Europe. Heretofore it has been impossible to compare the European broadcasters in a published table, because some rate themselves according to the entire power drawn from the sources of supply, sometimes more than ten times the actual radiation. Hitherto, a conservative rating has been considered that of the power of the carrier current delivered to the aerial. The result will be, presumably, a scaling down of the rating of the European broadcasters, some of which have been listed between 60 and 120 kilowatts, to below the American maximum of 60 kw.

## HOTEL DIRECTORY OF THE RADIO TRADE

# Hotel Dixie

42<sup>d</sup>-43<sup>d</sup> Streets West of Broadway

A New and Better Hotel for Times Square

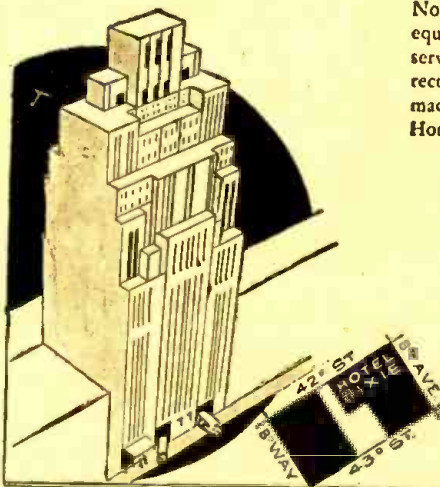

Not alone new in construction and equipment, but new in conception of service and comfort to its guests. Directed by S. Gregory Taylor, who has made such enviable successes of the Hotels Montclair and Buckingham.

#### Single Rooms

with tub and shower

**\$3, \$4 and \$5**

#### Double Rooms

with tub and shower

**\$4, \$5 and \$6**

A few terraced rooms and suites, exceptionally large closets, on an attractive monthly basis.

#### RADIO IN EVERY ROOM

Entrances on 42nd and 43rd Sts.

### CENTRAL UNION BUS TERMINAL

LOCATED IN THE DIXIE HOTEL BUS CONNECTIONS FOR ALL POINTS IN THE UNITED STATES

# The Belvedere

FORTY EIGHTH STREET

WEST OF BROADWAY

New York

Resident and Transient

450 OUTSIDE ROOMS

Each With Bath and Shower  
Serving Pantry

\$3 to \$6 PER DAY

Special Weekly or  
Monthly Rates

Best Food in New York



D. M. PEPPER  
MANAGING DIRECTOR

An announcement on page 326 will be of interest to every reader of RADIO-CRAFT. The few minutes spent in reading this will be well worth your time.



# SKINDERVIKEN Transmitter-Microphone- Amplifier Units



## A FEW USES FOR THESE UNITS

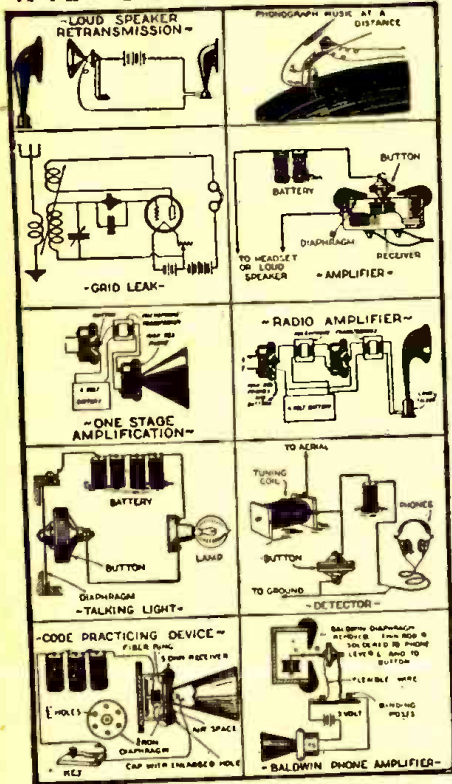

### HUNDREDS OF USES FOR THE EXPERIMENTER:

- RADIO AMPLIFIER
- PHONOGRAPH AMPLIFIER
- DETECTAPHONE
- TELEPHONE AMPLIFIER
- STETHOSCOPE
- LOUD SPEAKER AMPLIFIER
- MICROPHONE
- CRYSTAL SET AMPLIFIER

**WE PAY \$5.00 IN CASH**

for every new use developed for this unit and accepted and published by us.

**95c EACH**      Two for **\$1.75**  
**12-PAGE INSTRUCTION BOOKLET**  
containing suggestions and diagrams for innumerable uses, furnished with each unit.

EVERY AMATEUR SHOULD HAVE TWO OR THREE OF THESE AMPLIFIERS IN HIS LABORATORY

## SEND NO MONEY

When the postman delivers your order you pay him for whatever you have ordered, plus a few cents postage.

PRESS GUILD, Inc.      RC-12-30  
16 Murray St., New York, N. Y.  
Please mail me at once as many of the following items as I have indicated.  
... Skinderviken Transmitter Units at 95c. for 1; \$1.75 for 2; \$2.50 for 3; \$3.20 for 4.  
When delivered I will pay the postman the cost of the items specified plus postage.

Name .....

Address .....

City..... State.....

# Letters from Radio Craftsmen

(Continued from page 355)

the time; but I have a great love for experimental work with radio sets. I would greatly appreciate any "junk" and discarded radio parts that other readers would be willing to send me.

H. F. CLAWSON,  
811 Fifth Street, N. W.,  
Winter Haven, Florida.

## A SET WITHOUT A COIL

Editor, RADIO-CRAFT:

Some weeks ago with an aerial strung in the attic, and a Foote fixed (crystal) detector across my phones, between aerial and ground, I heard two locals, WHK and WHAM; WWO (the Cleveland Airport); and code—all at the same time. But tonight I have beaten this. With a tinsel cord and jackknife blade contact across the phones—no coil or condenser—I heard one of the local stations and WWO, whose announcer I heard plainly. It is very noisy here. This seems to go the Rev. Mr. Wells, whose "irreducible minimum" is pictured in your September Kinks page, one better.

RICHARD A. BELL,  
1957 West 100th Street,  
Cleveland, Ohio.

(Inductance is, of course, introduced into the circuit by the phones.—Editor.)

## FREQUENCY-CHANGING EXPERIMENTS

Editor, RADIO-CRAFT:

I was much interested in the short-wave converter designed by Mr. Watson Brown and described in the September issue of your magazine so I made it up and tried it out on a Silver-Marshall "No. 30" screen-grid tube set.

For the tuning coils I used a set of Dresner short-wave plug-in coils, which had been used in an ordinary short-wave set and which I had found quite satisfactory; but they did not work on Mr. Brown's hook-up. I was not even successful in tuning in a code signal; so I concluded that it was useless to continue experimenting with it any further.

The idea occurred to me, then, to use a second coil as an oscillator or frequency-changer on the standard superheterodyne principle; so I set to work and wound a coil that I thought would be about right. Within a few minutes, I picked up several stations with tremendous volume by attaching it to the aerial post of the set.

I found, however, that it was very difficult to get the two tuning dials in proper relation to one another; so, as a further experiment, I took out the first (tuning) coil and used the oscillator coil only. This affected, of course, the tuning by about 15 degrees on the dial; but no difference could be discerned, as regards the strength of the signal. The most outstanding feature in this arrangement is the fact that only one tuning condenser is used; it is without a variable condenser to obtain regeneration.

Quite obviously, the '27 tube acts as an oscillator and not as a detector; but it does not affect the quality of the reproduction. For tone and other desirable characteristics, and with the exception of rapid fading and

other short-wave idiosyncrasies, it gives the equal of ordinary broadcast reception.

I have picked up one foreign station, a telephonic broadcast from the S.S. *Ile de France*, and a few American stations, including New York, Chicago, Toronto, etc.; besides a considerable number of code signals. This is better than I have ever been able to obtain previously after many previous attempts with adapters, converters, etc.; and although it is a little early to form any definite opinion of it, the results are promising.

It has occurred to me that there are hundreds of radio set owners looking for something of this kind. Most of the time the static interference, especially in this city, is so that out-of-town programs are impossible until late in the evening; but I find that this converter eliminates most of it, so that programs can be listened to with enjoyment that would be impossible on the long waves.

This method, however, has its limitations and, so far, I have been unable to obtain signals below 40 meters; probably because a '27 tube does not oscillate freely at high frequencies. Sometimes stations from 48 to 52 meters can be received with tremendous volume, especially W3XAL. Amateurs operating on higher wave lengths also come in quite often, but that is all I have been able to get. This, however, is a step in the right direction and I would like to see other data published on this subject.

Mr. Hatry, apparently, favors D.C. for short-wave reception. I have built short-wave sets that operated perfectly by means of rectified current, using a Silver-Marshall "B" eliminator, and with very little A.C. hum; and therefore I think most of what has been written on this subject is pure nonsense. I also used the converter suggested by Mr. Brown in conjunction with a "B" eliminator for plate current, and obtained better results than with batteries; although batteries are quite satisfactory.

I would suggest that Mr. Hatry give some suggestions on building a converter that can be used in conjunction with a broadcast receiver. He suggests using as the intermediate frequency 1550 kilocycles, which is not far away from the ordinary broadcast band. Mr. Brown suggests 900 kilocycles which, I think, is more suitable for average requirements.

Having the necessary data for designing a frequency-converter, based on the superheterodyne principle, it would then be at the experimenter's option whether he ran the converted frequency through his broadcast set or built a complete short-wave receiver. The former is, no doubt, the ideal method and appeals to most.

Old-style receiving sets can be picked up cheaply almost anywhere. If, by adding a frequency-changer to them along the lines suggested, they could be converted into short-wave receivers, it seems to me to be an easy solution to a somewhat difficult and expensive problem and therefore more interesting from a practical standpoint.

J. Moss,  
4519 Mayfair Avenue,  
Montreal, Canada.



(As will be seen, this issue of RADIO-CRAFT contains additional material on this interesting subject. Mr. Hatry explains why, in designing a short-wave receiver, he finds 1550 kilocycles to be the best intermediate frequency. As for the converters, they must operate on some intermediate frequency available in a broadcast receiver, and best suited to reception with the particular set and location. Several readers find difficulty on low waves with an electric set and a converter using '27 tubes. Some makes of these tubes, as explained in previous articles on frequency-converters, do not oscillate properly at the low wavelengths, for which they were not designed; their plates are made of wire mesh. A '27 with a plate of sheet metal should be used, for best results.—Editor.)

RADIO AND X-RAYS

A RADIO tube and an X-ray tube both generate "cathode rays" — commonly called "plate current" in the former. In the X-ray tube, the very high voltages produced strike out from a metallic "target" waves of extremely short length, the penetration of which, through ordinarily opaque substances, is considerable.

A German transmitting amateur, says *Radiozeit* (Vienna), was impressed by the appearance of spots on the metallic inner coating of his tube, and was led to suspect that X-rays might be the cause. He found that an exposure of a photographic plate to the tube produced results similar to those of X-rays; and a fluorescent screen (barium-platinum cyanide) showed slight

flashes. In addition to this, an electroscope brought near the tube was discharged; indicating that radiation was producing ionization of the air within it. The Austrian magazine suggests this as an interesting field for experiment.

The question may be raised, whether the radiation thus produced is in the order of what are known as X-rays; or merely of ultra-violet light, which, though invisible, is of much longer wavelength? The velocity of the electrons in a radio tube, under ordinary voltages, is much less than in an X-ray tube. However, the field for work, even with ordinary tubes, is open to the inquiring experimenter who has photographic equipment.

TOO MUCH "OZONE"?

FROM Buenos Aires comes a report of a new occupational hazard which, if correctly founded, is worthy of consideration. One of the operators of a large broadcast station there developed heart trouble; which the physicians were inclined to ascribe to working in the midst of high-power, high-frequency fields. Sr. Segundo P. I. Acuna, a radio engineer and editor, in describing the case, attributes it, not to the current (which, at broadcast wavelengths, seems to have no physiological effect) but to the inhalation continually of ionized air, which has its effect indirectly through the lungs of a person breathing it. Such a hazard, of course, would be removed by proper ventilation, and it would not be experienced, in any event, around a low-power transmitter.

Remote Control Tuning

(Continued from page 356)

extension shaft made of 1/4-inch brass tubing was placed on the backs of two of them. This was accomplished by taking out the screw holding the switch lever, and replacing it with a longer screw over which the bushing had been slipped. Each switch was mounted upon a small piece of bakelite. The switches were then connected in tandem with insulated condenser couplings; after which the three pieces of bakelite were securely fastened together with machine screws and fiber tubing. This assembly was mounted behind the panel, through which the shaft of one switch extended. When the dial on this shaft is turned, the three

switches operate in unison. They are not, however, connected electrically.

Six 3/4-inch holes were drilled in the panel, and a pilot-light socket mounted behind each of them. A shield was placed between adjacent windows, to prevent the light from shining through more than one, and label holders (secured at a hardware store) were mounted behind each to hold the station designations. Two "midget" .0005-mf. variable condensers of the mica-dielectric type (such as the Pilot "Neutrograd" or the X-1 "Variodenser") were mounted behind each panel opening. It may be necessary to have condensers with a lower maximum capacity for the shorter wavelength stations. This can be accomplished by taking plates out of these condensers, if condensers with a lower maximum capacity are not available.

It will be noted that, when the switch is in the first position shown on the diagram, the regular tuning condensers and the dial lights are connected in the circuit. The set can then be tuned in the ordinary manner—an advantage not possessed by most switch-tuned sets I have seen described. When the switch is turned to the second position, the first pilot light and its two associated condensers are connected in the circuit; and so on for the other positions.

The call letters of the stations, which it is desired to tune by switch control, are typed on a piece of white paper, being written in such a position that, when placed

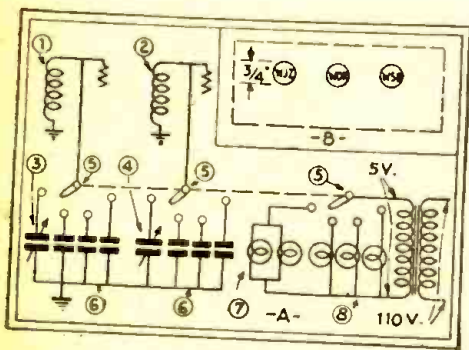
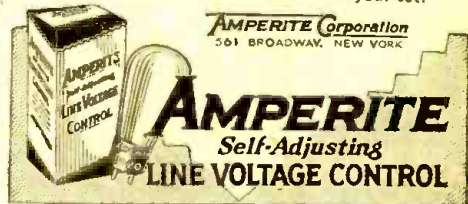

Fig. 2

The regular condensers are 3 and 4; the adjustables, shunted at 6, are selected by the triple switch 5-5-5. The regular dial lights are 7; the new ones 8 (arranged as at B.)

SMOOTHES OUT RADIO VOLTAGE "BUMPS"

The new AMPERITE for electric radio automatically prevents line voltage variation. AMPERITE improves performance. Lengthens tube life. It pays to buy and sell radios equipped for AMPERITE. Install AMPERITE in the set you now have. Ask your dealer, or write Dept. RC-12, giving name and model number of your set.



1931 LOWEST WHOLESALE PRICES! FREE RADIO CATALOG

Everyone interested in RADIO should have this Catalog. Solid with "Specials" from cover to cover. Teeming with values... every item a feature. All latest sets and equipment. Screen Grid, A. C., Humless, all electric sets... also battery operated sets and direct current sets. Dynamic speakers, beautiful consoles, kits and parts. Wholesale prices. Astounding savings. Get this FREE bargain book today  
Chicago Salvage Stock Store  
509 S. State St. Dept. 542, Chicago

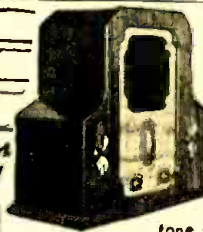

PILOT MIDGET \$59.50

This compact A. C. receiver in beautiful two-tone walnut cabinet gives radio performance of console quality. Produced in the internationally famous Pilot Radio plant. Full screen grid and electro dynamic speaker give the MIDGET outstanding selectivity and sensitivity. A typical 20th Century value—where you can get everything in radio, short wave kits, parts, tubes, accessories at lowest prices. The MIDGET, \$59.50, tubes \$16 extra, sent postpaid on receipt of \$18.75, balance C.O.D. plus transportation charges.

SEND FOR CATALOG and FREE RADIO GIFT 20th CENTURY MAIL ORDER CORP. 202 W. Jackson, Chicago, Ill.

RADIO BARGAINS

- Low Power Transmitter adaptable for phone or code.
- With plug-in coils
- Auto Radio—Uses 3 224 screen grids, 2 227 tubes and 1 245 power tube, single dial, tremendous volume.
- Compact. Fits any car. We guarantee this set to perform better than sets selling up to \$150... 20.00
- B Eliminator, Bone Dry with 280 tube, 180 volts, will operate up to ten tube set, fully guaranteed... 6.75
- AC-A B C Power Packs... 8.75
- Tubes: UX type, 30-day replacement guarantee, No. 210, \$2.25; No. 250, \$2.35; No. 281, \$1.85; No. 245, \$1.25; No. 224, \$1.25; No. 227, 75c; No. 226, 65c; No. 171, 75c.

CHAS. HOODWIN CO. 4240 Lincoln Ave. Dept. M-15 Chicago



# FREE



## Magazine Covers of Beauty for Practical Service

Read in comfort with your magazine held in the firm grip of this handsome cover. It is restful as a reading stand and much more convenient to use.

Its beauty adds to the neatness and attractiveness of your reception room or office. No longer will your copy of RADIO-CRAFT present a tattered and sorry appearance. It is protected by this handsome and sturdy cover. Available in colors of Red, Green, Blue, Brown and black. Title embossed in gold.

This attractive cover will be sent to each subscriber who sends in his subscription to RADIO-CRAFT for one year at the rate of \$2.50.

RADIO-CRAFT

98 Park Place New York, N. Y.

# TRUSS USERS

STUART'S ADHESIF PLAPAO-PADS are patently different—being mechanico-chemico applicators—made self-adhesive purposely to keep the musculo-tonic called "PLAPAO" continuously applied to the affected parts, and to minimize danger of slipping and painful friction. The fabric is soft as velvet, and being adhesive—

—clings closely to the body—

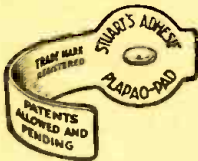

—without straps, buckles or springs.

Easy to apply, comparatively inexpensive and comfortable. For almost a quarter century stacks of sworn testimonials from many different countries report success, without delay from work. Process of recovery natural, after which no further use for a mechanical support. Test of the remedial herbal factor "PLAPAO" sent you absolutely **FREE**. No charge for is now or ever. Write name on coupon NOW and mail TODAY. Plapao Co., 10 Stuart Bldg., St. Louis, Mo.

Name \_\_\_\_\_  
Address \_\_\_\_\_  
Free — Trial Plapao — Free

## PATENTS TRADE-MARKS

DO NOT LOSE YOUR RIGHTS TO PATENT PROTECTION

Before disclosing your invention to anyone send for blank form "EVIDENCE OF CONCEPTION" to be signed and witnessed.

LANCASTER, ALLWINE & ROMMEL  
(Registered Patent Attorneys)  
475 Ouray Bldg., Washington, D. C.  
Originators of forms "Evidence of Conception"

**PATENTS** Write for Free Guide Book, "HOW TO OBTAIN A PATENT" and Record of Invention Blank. Send model or sketch and description of your invention for our Free Opinion whether it comes within Patent Office Rules. RADIO and ELECTRICAL Cases a Specialty. Prompt, Efficient Service. PAYMENT OF FEES IN INSTALLMENTS VICTOR J. EVANS & CO., 923 - 9th, Washington, D. C.

in the label holder, they are visible through the opening in the panel. In typing these, if the face of a piece of carbon paper is placed against the reverse side of the paper, it will make an imprint that will show more clearly. Two pieces of celluloid and a piece of thin colored paper (a different color for each station) are cut to the proper size for the label holder, and assembled as follows: first, celluloid; next, the typewritten designation slip; next, the colored paper; and last, the second piece of celluloid. The colored paper is not visible unless a station is being received; then, it appears as if a colored pilot light was being used. Tissue paper or any thin paper of the proper colors will do. (See Fig. B.)

We are now ready to tune in a station. The switch is thrown to the first position and the station selected in the ordinary manner. The switch is then turned until the call letters of the station we are receiving lights up. The semi-variable condensers are then adjusted until the same program is heard. It may be necessary to adjust these condensers again after a few hours; but the second adjustment should prove permanent.

## A SIMPLE REMOTE-CONTROL SWITCH

By H. Edwin Kaltwasser

THE writer has not as yet seen a practical remote-control switch for turning a set on and off from as many places as desired. Hence, the following idea. It's simple and it works.

A solenoid was made as follows: two washers, (Fig. A) 1 inch in diameter were cut from scrap bakelite with a circular cutter. The center holes were made just large enough to be forced over a piece of brass tubing (Note: brass tubing must be used.) 1/4-inch inside diameter and 2 1/2 inches long. One washer was provided with two small holes for flexible leads. Wax paper was then wrapped around the brass tube, and over this 1 1/2 ounces of No. 32 enameled wire was wound at random, the ends being

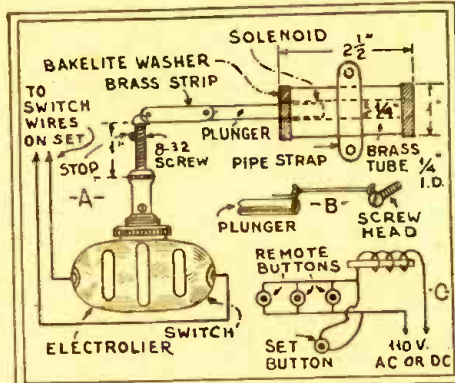

The magnet shown above may be used to operate a spring switch, of the type which turns a lamp on and off by successive pulls. It thus makes a convenient remote control for an electric set.

soldered to flexible leads. Heavy paper was wrapped over the wire for a covering. So much for the solenoid.

The plunger was made from a 4-inch iron nail which happened to be a trifle less than 1/4-inch in diameter, cut to 2 1/2 inches in length. On one end was soldered a small hook, made of a thin nail (Fig. B).

Figure A shows an "Electrolier" or can-

## CLASSIFIED ADVERTISEMENTS

Advertisements in this section are inserted at the cost of ten cents per word for each insertion—name, initial and address each count as one word. Cash should accompany all classified advertisements unless placed by a recognized advertising agency. No less than ten words are accepted. Advertising for the January 1931 issue should be received not later than November 7th.

### DETECTIVES

DETECTIVES Earn Big Money. Excellent opportunity. Experience unnecessary. Particulars Free. Write, George Wagner, 2190B Broadway,

### INSTRUCTION

LEARN TATTOOING. Instruction catalog, dime. Miller, N431 Main, Norfolk, Virginia.

### INVENTIONS

INVENTIONS COMMERCIALIZED. Patented or unpatented. Write Adam Fisher Mfg. Co., 594 Enright, St. Louis, Missouri.

### MISCELLANEOUS

LOCATING BURIED TREASURE by radio offers you pleasure and profit. Unbelievable success. Fascinating. Details for Red Stamp. Exchange, Box 607, El Monte, California.

### PERSONAL

WOULD YOU MARRY? Your plan—we win—you win—thousands happy clients—well-to-do members everywhere. Information plain sealed envelope. The Circle, Middletown, Indiana.

### RADIO

SERVICE MEN, ATTENTION—Speakers re-wound, magnetized, repaired, \$2.00 to \$2.75. Complete Power Pack Service—Transformers rewound, condenser blocks repaired, resistors duplicated. Guaranteed. Clark Brothers Radio Co., Albia, Iowa.

GET MORE DISTANT STATIONS—New frequency selector—guaranteed—\$1.00 postpaid. Noel, 1502 Pittston, Scranton, Penna.

POWER TRANSFORMERS, speakers, condenser blocks repaired. Radio frequency chokes, 20c. Eric Anander, Manchester Road, Jamestown, New York.

### SONG POEM WRITERS

SONG POEM WRITERS—"Real" proposition. Hibbeler, D153X, 2104 Keystone, Chicago.

# SONG WRITERS

Advance Royalty Payments, New Talking-Picture Song requirements, etc., fully explained in our Free instructive book. Writers of Words or Music for songs may submit their work for free examination and advice. Past experience unnecessary. We revise, compose, arrange music and secure Copyrights. Our modern method guarantees approval. Write Today—Newcomer Associates, 1678B Broadway, New York, N. Y.

## DO YOU WANT TO STOP TOBACCO?

Banish the craving for tobacco as thousands have. Make yourself free and happy with Tobacco Redeemer. Not a substitute, not habit forming. Write for free booklet telling of injurious effect of tobacco and dependable, easy way to relieve the craving many men have. **FREE BOOK** Newell Pharmacal Co. Dept. 928 Clayton, Mo.

# Outdoor Jobs

Get Forest Ranger, Park Ranger or Game Protector job: \$140-\$200 month; vacation; steady jobs; patrol forests and parks; protect game. Quality now. Write for full details.

DELMAR INSTITUTE Dept. B-39 DENVER, COLO.

## WE MATCH PANTS

To Any Suit!

Double the life of your coat and vest with correctly matched pants, 100,000 patterns. Every pair hand tailored to your measure. No "readymades." Our match sent FREE for your O. K. before pants are made. Fit guaranteed. Send piece of cloth or vest today. SUPERIOR MATCH PANTS COMPANY 115 So. Dearborn Street, Dept. 381, Chicago



opy switch, obtainable in any electrical supply store. (First pull closes circuit; resets automatically by spring; second pull opens circuit.) The short chain was removed and the hole threaded for an 8-32 brass machine-screw, 1 inch long. Another small hook was soldered into the slot on the head of this screw. These hooks were joined by a piece of brass strip, 1 inch long and 1/4-inch wide, with a small hole on each end. A mounting bracket was then fastened under the large knurled nut on switch.

The entire apparatus was attached to a small board, and a wood-screw was provided (Fig. A) as a stop to prevent the plunger from coming out of the solenoid; which was mounted with a pipe strap and adjusted

for the proper plunger stroke. The completed control was then mounted in the radio cabinet.

Next, the switch on the radio set was removed and replaced with a midget push button, which was wired to the same line as the remote buttons (Fig. C). The wires removed from the set switch were connected to the "Electroliner" switch.

A remote button may be placed in any room; only two wires are necessary for any number of buttons.

The operation is simple. Press any button once, and the set is turned on; press any button again, and the set is turned off.

The entire cost of building this control (except for the buttons) was less than \$1.00.

## Radio-Craft Kinks

(Continued from page 357)

transformer of an old Philco trickle charger as the filament supply unit for a type '45 power tube. Naturally, any tube having a 2 1/2-volt filament may be heated in the same manner; and, by changing the number of secondary turns, a 1 1/2- or 5-volt filament.

The case is removed from the transformer and the laminations pulled out. The secondary windings are then removed, and the core rewound with No. 16 S.C.C. wire. (As different makes of transformers vary in wattage output it is difficult to state the exact number of turns to be wound.)

A simple test of correct number of secondary turns is as follows: after winding what is thought to be the correct number of turns for the secondary, (perhaps 10 to 15 turns, for a 2 1/2-volt winding; other sizes in the roughly approximate ratio of 5 turns per volt), replace the laminations and connect the transformer primary to the 110-volt A.C. line. Now, connect an A.C. voltmeter across the new secondary, and note the output.

If an A.C. voltmeter is not available, an old '99-type tube may be brought into service as a visual indicator of the approximate output of the supposed 2 1/2-volt secondary. If it glows dull red when shunted across the secondary leads, add turns; if very bright, remove turns. The '45 tube filament burns with a dull red glow on 2 1/2 volts.

Before connecting the transformer into the operating circuit, check both primary and secondary for shorts and, more particularly, grounds to each other and to the

core. The latter should be insulated from the secondaries and grounded.

Three of the stages, winding the secondary, replacing the laminations, and the finished assembly, are illustrated in Figs. A and B.

### THE PERSONAL TONE CONTROL

By Louis Rick

THE idea of tone control is so old it has whiskers; but, like most bewhiskered gentry, it has a modern descendant. In this instance, we find the radio sets of today are equipped with a timbre-modifying arrangement in which the central position of the control knob corresponds to the normal quality output of the receiver; while moving the knob to left or right accentuates either the bass or treble.

Service Men may introduce this modern twist (Hi!) into the older receivers by following the schematic circuits shown in Fig. 4. (A, recommended circuit for sets having the output push-pull; B, connections to single power tube.

Condensers and R.F. choke made into a unit (as at C) may be mounted directly on the output transformer; the potentiometer P being placed where most convenient.

A final and "commercial" touch is obtained by placing a piece of white celluloid, marked with India ink, underneath the potentiometer arm, as shown at D.

The result is a modern and almost unbeatable tone control.

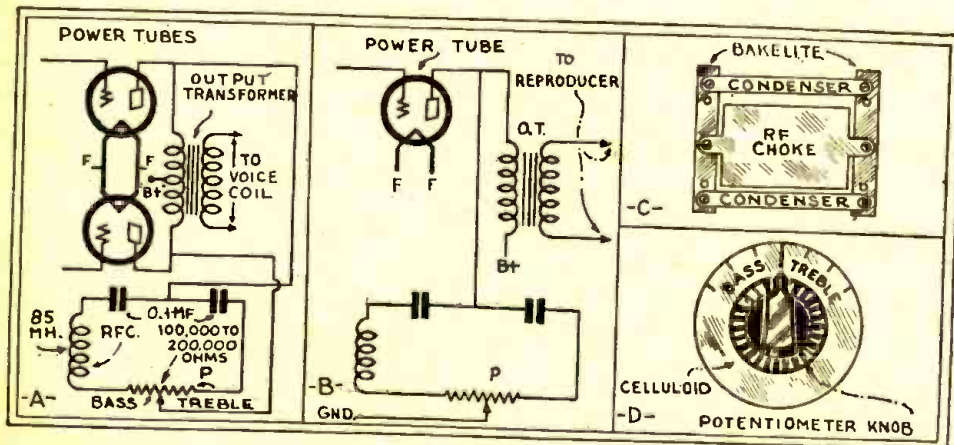

Fig. 4

The experimenter who wishes to build his own tone control will find a handy method here; the device is easily made and easily connected.

**WORLD-WIDE**  
**ONLY 6.45**  
**SHORT WAVE RECEIVER**  
 Span the World with this Set!

A new radio thrill for you! Listen in DIRECT to London, Paris, Berlin, Buenos Aires and other broadcasting stations throughout the world via short waves. Enjoy unique foreign programs from strange lands. Your ordinary receiver cannot tune in these low wave stations. **WORLD-WIDE RECEIVER** gets 11 to 550 meter stations with surprising clarity. **SEND NO MONEY!** Just write your name and address on a postcard and ask us to send you this wonderful guaranteed short wave set. Pay postman \$6.45 plus a small delivery charge. All orders West of the Rockies must be accompanied by \$1.00 deposit. Foreign countries must remit in full. Write today!

CHAS. HOODWIN CO.  
 4240 Lincoln Ave., Dept. M-150, CHICAGO

### SPECIALS

- WESTERN ELECTRIC HAND MICROPHONES. Switch in handle. Very sensitive. Just the thing for that Home Broadcaster, etc. Brand new. ONLY \$3.95
- RCA 7-Mfd. 650-Volt D.C. Working Filter Condensers. Metal cased. Replacement in No. 104 Speaker \$2.50
- FARADON CONDENSER BLOCKS. 1 1/2-Mfd. 1,000-Volt and 2-Mfd. 600-Volt D.C. Working. Fine for Filter Packs, etc. \$1.45
- RCA Output or 3:1 Audio Transformers. 90c. Each. Four for \$3.00

SEND FOR OUR NEW BARGAIN BULLETIN!!

**HARRISON RADIO CO.**  
 189 Franklin St. Dept. R N. Y. City

**Radio's Biggest Values**

Up-to-the-minute offerings at lowest wholesale prices. Includes newest Tune Control, Screen Grid Superheterodyne, Radio-Phonograph combinations, short wave receivers, automobile radios, public address. Attractive walnut consoles and latest accessories, parts and kits. Don't buy until you see our big catalog.

**Send for FREE Complete Catalog**

**Western Radio Mfg. Co.**  
 128 W. Lake St. CHICAGO

**STUYVESANT ELECTRIC CO.**  
 53 Walker Street - New York

Write for **FREE CATALOGUE** ON LATEST RADIO BUYS

**ALUMINUM BOX SHIELDS**

Beautiful silver dip finish, 5" x 9" x 6" \$1.89; 10" x 6" x 7", \$3.25. We make any size to order.

4" x 4" x 5" knockdown coil shield (see picture on left), \$1.00.

25 Sprague Midget Cond., 50c; 7-Plate Midget Cond., 50c; 4 and 5-prong plug-in coil forms proved for wire, 45c; drum dial drive cable by foot or mile. Include sufficient postage for shipment.

**BLAN, The Radio Man, Inc.**  
 89T Cortlandt St., New York, N. Y.

**MICROPHONES**

For Transmitters - P. A. Systems and Recording, also cables, accessories and repairs. Catalog just out.

**UNIVERSAL MICROPHONE CO., LTD.**  
 Inglewood, California



# Increase Your Earning Power

Whatever your job, you will find in **EVERYDAY MECHANICS** labor-saving kinks which will help you to get more work done in less time and will bring you recognition from your employers. If you do machine shop work of any kind, auto repairing, sheet metal work, electrical work, farming, concrete work, carpentering, tool making, poultry raising, painting, plumbing, masonry, building, glass work, welding, or general repairing, a yearly subscription to **EVERYDAY MECHANICS** will pay for itself a thousand times over.

15c The Copy



On All Newsstands

## Make Money in Your Spare Time

Hundreds and thousands of amateur mechanics and spare-time workers are making \$10 to \$100 a week **EXTRA MONEY** by servicing vacuum cleaners and washing machines; repairing automobiles; manufacturing book-ends, lamp-shades, tool chests, chairs, tables, unique ornaments, concrete articles, photo frames, flower boxes, gliders, and innumerable products in everyday use. **EVERYDAY MECHANICS** teaches you **HOW** to turn your spare time into **MONEY**.

### Contents

**SPACE DOES NOT PERMIT US TO PRINT ALL THE FEATURES IN THE CURRENT ISSUE OF EVERYDAY MECHANICS.** But the following titles will give you some indication of the interesting and valuable contents: Automobiles, Aviation, Chemistry, Construction, Photo, Electricity, Magic, Metal Work, Radio, Photography, Shop Work, Woodworking and new devices.

### A Special Offer

In order that you may not miss any of the splendid features now appearing in **EVERYDAY MECHANICS** and opportunities for making money from the unique "tips" that are published in every issue, the publishers will send this valuable magazine **DIRECTLY TO YOUR HOME** every month at a reduction of **ONE-THIRD** off the usual subscription price. But to take advantage of this offer you must act quickly. Tear out the coupon below and mail it today. **YOUR FIRST COPY OF EVERYDAY MECHANICS WILL BE SENT YOU BY RETURN MAIL.**

### Mail Coupon Today

**EVERYDAY MECHANICS PUB., Inc.** RC-12  
96-98 Park Place, New York, N. Y.

Please rush my first copy of **EVERYDAY MECHANICS**.  
I enclose

- \$1.00 for one year's subscription
- 1.90 for two years' subscription
- 2.70 for three years' subscription

(Check one of the above)

NAME .....

ADDRESS .....

CITY..... STATE.....

NOTE: This special subscription offer may be withdrawn at any time.

# A New Element in Tube Design

(Continued from page 359)

former's windings. However, by the system shown in Fig. 1, a counter-voltage from the auxiliary electrode may be applied to the transformer through a separate winding, to combat resonance; and other methods of coupling may be employed as well.

To illustrate the possibilities of circuits which may be devised with a tube of this nature, Fig. 2 shows several methods of coupling, combined in a single receiving set. The signal is applied through the antenna-coupler secondary L1 to the tuned circuit C1-L2 and, through this, to L3-C2, the tuned input of V1, the output of which is resistance coupled to the next tube. Any number of similar R.F. stages may be applied before the detector, which is shown as V3. It will be observed that only one side of the filament circuits is shown; if they are to be operated by alternating current, the connections would be then of the type of Fig. 3.

(Editor's Note: While Mr. Dalpayrat's patent application was filed some time ago, tubes of the type which he described have not been put upon the market. However, since that time there has arisen a practice of applying positive potentials to the filament heater of the '27 tubes, which causes to a certain degree the action which he describes; although the tube was not originally designed for that purpose. To utilize the heater circuits, with their alternating current, for purposes of neutralization, etc., is perhaps impractical; but the custom of building battery sets using '24 and '27 tubes, originated by the demands of automobile

radio, affords to the ingenious constructor some opportunity to experiment along the lines explained in this article. While there is a high resistance between the cathode and the heater of such a tube, at normal operating temperatures when both are emitting electrons freely, the path between them is conductive. In **RADIO-CRAFT** for July, 1930, Mr. Grimes discussed this very point, and pointed out that, when the heater's potential is at about 10 volts, positive, above the cathode's, the intervening resistance is about a megohm; it decreases rapidly as the positive voltage of the cathode increases. Little is yet available in published form on this subject; and it should therefore appeal to the experimenter.)

## THE RECORDED PROGRAM

**W**HILE in the United States, official objection has been expressed to record reproduction, as not true broadcasting, no such sentiment can be found abroad. In every other country, stations announce their programs well ahead; and "disques," "schall-platten," etc., figure liberally in the numbers. One the greatest opportunities for the exploitation of record production here, however, lies in the chain programs and the extensive distances, spread through four time zones. The supply, in advance, of records to different stations reduces the need for wire lines, and it also permits a national program to be presented at the most suitable hour in each zone. For this purpose, special care in recording and high-quality pick-ups are essential.

# RADIO-CRAFT'S INFORMATION BUREAU

(Continued from page 360)

primarily to deliver high voltage D.C. to a small transmitter. Its receiver capabilities were not developed; although evident.

"If you are to build it for the purpose mentioned, however, buy one of the resistance outfits for reducing the 32 volts of a farm lighting plant to 6 volts. Then introduce sufficient resistance in place of the flashlight bulb to pass enough current to the converter commutator to build up the required current consumed by the 8-tube set. (I used a 4-segment commutator from an old motor for my purpose and it worked okey.)"

(Q.2) Mr. Wm. F. Jones, Springfield, Ohio.

In reference to the article, "'B' from Storage 'A,'" in the July, 1930, issue of **RADIO-CRAFT**, I would like a little more information.

A customer wants me to install a public address system in a "Model T" Ford. He desires an A.C. installation if possible, and wants to use an A.C. turntable. Would the generator described operate an A.C. turntable and amplifier system, using a 150-ampere-hour battery connected to the Ford generator?

(A.2) Regarding this inquiry we are advised by Mr. Robbins as follows: "I am not at all sure that this would supply the phonograph turntable and the receiver. Mine was used almost solely for amateur transmitter operation, and only a very little on the receiver. It would be a case of build and try." However, it may be mentioned that larger output will be obtained by changing the size of the lamp in the socket; as pointed out in the reply, above, to Mr. Snyder.

(Q.3) Mr. John J. Hogan, Medford, Mass. While the story on obtaining A.C. through the use of a storage battery is of great interest to me, I find it difficult to obtain a motor having the design specified in the article. What other information is there available on this unit? I intend to use this "B" supply to run a portable three-stage amplifier, with a stage of push-pull '45's.

(A.3) "The motor used in this converter," states

Mr. Robbins, "was a "Model 700," made by the Knapp Electric Co., Port Chester, N. Y. I believe this converter would meet the conditions mentioned; although this is experimental and no practical data is available." Although the output of the converter may be controlled by the size of the lamp-resistor, care must be taken to use a storage battery well able to deliver the required current output without being overloaded, and to keep the battery well charged.

## WHISK "UNIVERSAL" RECEIVER

(100) Mr. Robert Davies, Providence, R. I. (Q.) In this article, "The 'Universal' Broadcast Receiver," by Samuel Whisk, there is no mention of resistor R10, the grid leak in the input circuit of V9, the first R.F. stage in the short-wave portion of the set. What is its value?

(A.) R10 is a Durham 1-meg. metallized grid leak. Other values should be transposed to read: R11, 450 ohms; R12, 3 meg. R13 also is a 500,000-ohm Durham metallized grid leak.

## WATSON BROWN'S S-W CONVERTER

(101) Mr. Frank D. Smith, Jr., Washington, D. C. (Q.) After carefully following the directions appearing in the September, 1930, issue of **RADIO-CRAFT** in the article, "Short-Waves on Your Broadcast Receiver," by Watson Brown, I still have been unable to get the converter to operate on the lower wavelengths; that is, those below 60 meters or so. A Zenith "Model 52" is being used as the broadcast receiver. What can be the trouble?

(A.) Mr. Brown has done some more work on this interesting and effective converter, and his remarks are worth noting: "Apparently you have failed to connect the set up quite right. I would suggest that you use a separate filament transformer and an Arcturus or Pilot '27' tube. It is



most important, too, that you have your power supply and switch not over twelve inches from the 'A' and 'G' posts on the Zenith '52.' Also two condensers C5 (of 0.5-mf. capacity) should be mounted, one on each side of the filament transformer, and the connections run direct.

"Have you tried 45 volts on the plate? The shorter the cable that leads from your set to the smoking stand, the easier it is to cut out locals. (I have no trouble like this—even when lightning is bad on the broadcast band.) A metal chassis should be used, by all means. The use of a 15-foot aerial might result in considerable improvement in operation of the receiver.

"Since this article was published I have had a lot of fun with the very instrument pictured. Using it in conjunction with an Atwater Kent 'Model 60' receiver, I have picked up the transmissions from London, Sydney (Australia), Holinas and Oakland (Calif.), Mexico City, and a 'raft' of closer stations; all of them daytime reception at loud-speaker strength."

It is possible that some of the parts in Mr. Smith's completed converter are defective. The "Model 52" Zenith has an unusual input arrangement; the secondary of the first R.F. transformer is tuned by a variable condenser, as usual; but the connection between the grounded side of the variable condenser and the ground end of the coil is made through the primary or antenna winding (therefore, the primary is in series with the secondary winding and the chassis ground). This primary winding is by-passed by a fixed condenser which is across the tuned secondary circuit.

The aerial connection is optional; both a direct lead and a variable capacity coupling to the primary being provided. It is possible that changing the value of the antenna variable condenser would result in considerable improvement, with the converter connected to the "Long Ant." post. (This diagram appears on page 320 of the OFFICIAL RADIO SERVICE MEN'S MANUAL.)

As shown on page 328 of the same manual, the "A. K. 60" used with the original converter model has a regular tapped-primary type of R.F. transformer.

(Readers might find it of interest to check the input and output circuits of the converter against the several means of connecting an adapter shown in the diagram of the Work-Kite (Walker) "Flexi-Unit" illustrated on page 203 of the October-November, 1930, issue of SHORT-WAVE CRAFT.)

#### STATEMENT OF THE OWNERSHIP, MANAGEMENT, CIRCULATION, ETC., REQUIRED BY THE ACT OF CONGRESS OF AUGUST 24, 1912.

Of Radio-Craft, published monthly at Mt. Morris, Ill., for October 1, 1930.

State of New York ss.  
County of New York

Before me, a Notary Public in and for the State and county aforesaid, personally appeared Irving S. Manheimer, who, having been duly sworn according to law, deposes and says that he is the business manager of Radio-Craft and that the following is, to the best of his knowledge and belief, a true statement of the ownership, management, etc., of the aforesaid publication for the date shown in the above caption, required by the Act of August 24, 1912, embodied in section 411, Postal Laws and Regulations, to wit:

1. That the names and addresses of the publisher, editor, managing editor, and business managers are: Publisher, Techni-Craft Publishing Corporation, 404 North Wesley Ave., Mt. Morris, Ill. Editor, Hugo Gernsback, 98 Park Place, New York City. Managing Editor, R. D. Washburne, 98 Park Place, New York City. Business Manager, Irving S. Manheimer, 98 Park Place, New York City.

2. That the owners are: Techni-Craft Publishing Corporation, 404 North Wesley Avenue, Mt. Morris, Ill. Hugo Gernsback, 98 Park Place, New York City. Sidney Gernsback, 98 Park Place, New York City. D. Manheimer, 98 Park Place, New York City.

3. That the known bondholders, mortgages, and other security holders owning or holding 1 per cent. or more of total amount of bonds, mortgages, or other securities are: None.

4. That the two paragraphs next above, giving the names of the owners, stockholders, and security holders, if any, contain not only the list of stockholders and security holders as they appear upon the books of the company but also, in cases where the stockholder or security holder appears upon the books of the company as trustee or in any other fiduciary relation, the name of the person or corporation for whom such trustee is acting, is given; also that the said two paragraphs contain statements embracing affiant's full knowledge and belief as to the circumstances and conditions under which stockholders and security holders who do not appear upon the books of the company as trustees, hold stock and securities in a capacity other than that of a bona fide owner; and this affiant has no reason to believe that any other person, association, or corporation has any interest direct or indirect in the said stock, bonds, or other securities than as so stated by him.

IRVING S. MANHEIMER,

Sworn to and subscribed before me this 10th day of October, 1930.

ROZELLA BENNETT, Notary Public.

(My commission expires March 30, 1931.)

# BARGAINS

## THORDARSON Input and Interstage Transformers



A Transformer possessing a ratio of 2 to 1. Built primarily for use with 210, 250 and 245 types of power tubes in push-pull stage. Size 3 1/2 x 3 x 3 3/4. Weight 3 1/2 lbs. List, \$12.00

Your Price, \$3.95

## B.B.L. GIANT ELECTRIC Motor Speaker Chassis

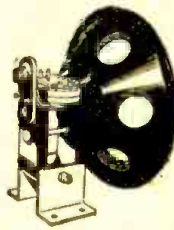

Contains a GIANT MODEL UNIT. Note the HUGE MAGNETS. Surpasses all other magnetic speakers, and most dynamics. Every note and tone in the musical register is faithfully reproduced, with no distortion or rattles. MUSIC AS IT SHOULD BE. Equipped with switch arrangement offering choice of 3 impedances to match any amplifier output characteristics—an exclusive feature. No field current required—no rectifiers. Shpg. wt., 10 lbs.

No. 421-E-2. 9" DIAPHRAGM. List, \$14.00

Your Price, \$7.25

## ANALYZER and TUBE TESTER



Our Special Price \$11.95

This reliable meter selling for considerably more than many others on the market meets the demands of every service man most efficiently. Its sturdy construction and accuracy in testing voltages, tubes, open circuits, etc., assures you satisfaction and long use. This meter is identical in construction and resembles others which wholesale from \$60 to \$100.

WHAT IT DOES FOR YOU!

Shows A.C. and D.C. Filament Voltages.

Tests Plate and Grid Voltages (also Screen Grid Voltages)

Indicates Plate Current and Lino Voltage

Shows Open Circuits and Grounds

Tests A.C. and D.C. Tubes

This exceptionally fine meter makes every essential test on the radio set.

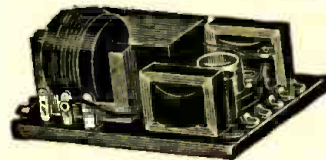

## COMBINATION "A.B.C." POWER PACK

WIRED READY FOR USE Built with high-grade parts. Supplies "A.B.C." Voltages for 4-220's, 2-227's, 2-171-A's, 1-280 105-120 Volts — 50-60 Cycle Delivers over 125 Mills and up to 300 volts "B" power. The Power Transformer is designed to take care of a D.C. DYNAMIC SPEAKER, two connections being provided on the pack for same. It need not be used if not wanted, but may come in handy at some future date.

Price Now \$6.75

All products shipped C.O.D. immediately upon receipt of order.

**GREN PARK TOOL CO.** 245 Greenwich Street New York, N. Y.

## Book Lovers Ex-Libris-Book Plates

LATEST series of OLD MASTERS book-plates, reproducing antique woodcuts and engravings. Unique creations for book-lovers who appreciate the unusual. Write for illustrated catalogue and specimen, enclose 10 cents for mailing charge. ISKOR PRESS, INC., 19 Park Place, Dept. D-1230, New York, N. Y.

WRITE FOR CATALOGUE

At the tremendously low prices at which the merchandise below is offered, every radio dealer, service man or mechanic should equip himself with stock for future use. It is probable that such low prices will not prevail for long.

## SONORA CABINET with Peerless 12-inch Auditorium Dynamic Speaker

positively the last word in the most efficient and powerful reproducer made! As a fitting companion, it is housed in a truly exquisite deep two-tone walnut console, of rare beauty and craftsmanship! To properly baffle the ultra-powerful Peerless chassis, a chamber 12" deep, 17 3/4" wide and 18" high houses same. Front baffle of 3/4" thickness! Ideal for use with the most powerful public address amplifier. NO RATTILING, NO DISTORTION — JUST PERFECT REPRODUCTION!

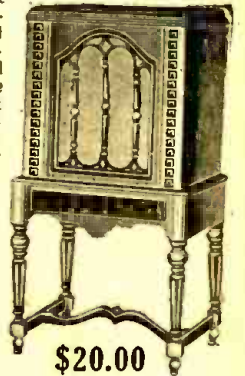

\$20.00

For that matter it is equally suited with ordinary sets, employing the average type of audio amplification systems, using as low as 90 volts "B" current! Will work with any set, regardless of output characteristics. Overall dimensions: 40" high, 24" wide, 15" deep. For 110 volt, 50-60 cycle A.C. Shpg. wt., 60 lbs. No. 408-A-50. List, \$155.00.

## DRY ELECTROLYTIC CONDENSERS



No. 1006



No. 1007-8-9



No. 1003-4-5

Absolutely dry—mount in any position! SELF HEALING—NEVER BLOW OUT! High voltage rating—occupy surprisingly small space, considering high microfarad capacity. Much less expensive than paper dielectric condensers! Clever mounting facilities. IDEAL FOR REPLACEMENT PURPOSES, as well as installation in new power packs! 500 volt D.C. PEAK rating. (Use two of each capacity desired for 250 tube power packs.)

No.	Mfd.	odes	Dia.	Length	List	YOUR PRICE
1003.	1	1	3/4"	2 1/2"	.55	.....\$0.27
1004.	2	1	1"	2 1/2"	.90	......44
1005.	4	1	1 1/2"	2 1/2"	1.70	......84
1006.	8	1	1 3/4"	4 1/2"	2.50	.....1.24
1007.	16	2	3"	4 1/2"	4.25	.....2.12
1008.	24	3	3"	4 1/2"	5.50	.....2.75
1009.	32	4	3"	4 1/2"	7.50	.....3.74



## Big Magic Set \$1.00

Contains Magic Wand, Obedient Egg, Marble and Dase Trick, Pencil and Loop Trick, Hindu Beads, Vanisher, Card Trick, Complete Instructions and our 64 page illustrated Catalog prepaid \$1.00

SCIENTIFIC NOVELTY CO. 98a Park Place, N. Y. City



# Sensational Sale of Radio Tubes

The Largest Variety of Tubes in the World!

Our previous sales have proven to be such great successes that we have decided to continue to sell tubes to the trade at tremendously low prices for several months, but the prices are subject to change later. Therefore, to be sure that your supply does not run low, NOW is the right time to buy and SAVE considerable money.

As manufacturers of private brand tubes, it enables us to place on the market a tube as good as any already on the market far below competitive prices.

Service men, dealers, radiotricians and jobbers will benefit by this unusual sale as ALL TUBES ARE WARRANTED TO BE PERFECT and tubes that are returned within five (5) days will be exchanged for new ones free of charge.



All tubes come in an attractive carton.

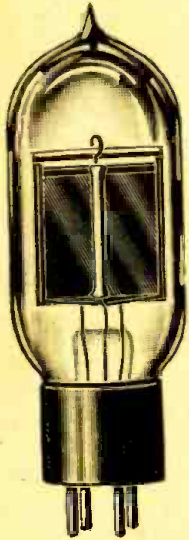

Tellon Television Tube \$3.85



2-inch Photoelectric Cell. \$3.85

THIS IS YOUR CHANCE TO CASH IN ON REAL BARGAINS.

Order from this page and note particularly the following terms:

NO ORDERS ACCEPTED FOR LESS THAN \$5.00.

ALL PRICES ARE F.O.B. NEWARK.

NO REPLACEMENT AFTER FIVE (5) DAYS.

IT IS NOT NECESSARY TO SEND FULL AMOUNT OF CASH WITH THE ORDER AS LONG AS YOUR ORDER IS ACCOMPANIED BY 20% OF THE VALUE.

SHIPMENT WILL GO FORWARD TO YOU BY EXPRESS OR PARCEL POST C.O.D.



High Grade (Hi Mu) 201A Type—better vacuum—works and fits in any set. \$0.60



A.C. Adapter Tubes to convert battery sets into A.C. Electric sets—furnished for 226, 227, 171A. \$0.60

## Tubes Shipped Immediately

TYPE	ANY QUANTITY
UX 201A—Amplifier or detector—standard for all purposes.	\$0.30
UX-226—Used as amplifier tube for A.C. operation.	.30
UY-227—Used as detector amplifier for A.C. operation.	.30
UX-171A—Power output amplifier for A.C. or D.C. operation. 1/2 amp.	.30
UX-171—Same characteristics as the 171A on tungsten filament. 1/2 amp.	.40
UX-210—Designed for impedance and resistance coupling.	.40
UX-120—Power amplifier used in last stage of audio frequency of battery set using dry cells.	.40
UX-199—Detector and amplifier tube, long prongs.	.40
UX-199—Same characteristic as UX199 only short prongs.	.40
UX-199—Standard base, same characteristic as UX199 only 201A base.	.40
UX-112—Power amplifier tube. 1/2 amp.	.40
UX-112A—Power amplifier tube for low current consumption. 1/2 amp.	.40
UX-200A—Detector tube recommended for weak signals and good reception.	.40
UY-224—Screen grid, four element, used as frequency amplifier and linear power detector.	.40
UX-245—Power amplifier tube used in last audio stage—for low plate voltage.	.40
Quadrode 5-prong 201A for special circuits.	.40
Special detector tube 200A—a super-sensitive detector.	.60
Special radio frequency 201A—a super-sensitive 201A.	.60
Special audio frequency 201A—a super-sensitive 201A.	.60
Special 171 A.C. 1/2 amp. extra coated filament—good for electric sets.	.60
T-14 (201A High Mu) high emission.	.60
Switch tube, 201A or 112 or 171 double life.	.60
Adapter tube 226, 227, 171A, to convert battery sets into A.C. each.	.85
UX-210—For power amplifier, high voltage.	.85
UX-250—Power amplifier used in last stage of audio frequency.	1.00
All bakelite shield tube 201A.	1.10
UX-222—Screen grid radio frequency amplifier.	3.85
Tellon television tube.	3.85
Photoelectric cell, 2-inch	

### RECTIFIER AND CHARGER BULBS

125 Mill. rectifying tube (P.H. type)	1.40
2 amp. old and new type charger bulbs (list \$4.00), our price.	2.00
5 and 6 amp. old type charger bulbs (list \$8.00), our price.	3.75
UX-280—Used as a full-wave rectifier tube for high emission.	.40
UX-281—Characteristics similar to the 280 but used as half wave rectifier of high emission.	.85
Rectifying Tube, especially designed for use with Freshman Master "B" Eliminators, UV brass base, limited quantity	.30

### DISCOUNTS:

50 tubes and over 10%  
500 tubes and over 10% & 10%



Switch Tube \$0.60  
Switch is used when one filament burns out, tube therefore has twice normal life. With switch on acts as 171 or 112 Power Tube—with switch off it is 201A Tube.



5-Prong 201A \$0.60

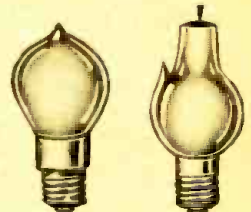

2-Amp. Charger Bulbs. \$2.00



5 and 6-Amp. Charger Bulbs. \$3.75

**ARCO TUBE COMPANY**  
38-40 PARK PLACE - - - NEWARK, N. J.



# RADIO'S GREATEST VALUES!

ALL merchandise listed is BRAND NEW and is shipped in the original, factory sealed cartons and carries the same guarantee of ABSOLUTE SATISFACTION! Due to the demand for this seasonal merchandise actually exceeding the available supply, ACT IMMEDIATELY! (We reserve the right to return remittances, as soon as the

supply of any one item is exhausted.) In most instances, our SALE PRICES ARE LOWER THAN THE ACTUAL MANUFACTURERS' COST! Join the ever swelling ranks of our 100% SATISFIED CUSTOMERS—WE HAVE YET TO RECEIVE OUR FIRST COMPLAINT.

## Stewart-Warner Magnetic Chassis

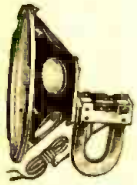

New 1930 Self-Buffed Dynaphonic Type. Do not confuse with earlier and cheaper models. An ultra-sensitive, loud speaker. Produced by one of radio's greatest companies. Extremely sensitive, tremendous volume without distortion or rattling. Reproduces with absolute fidelity. Speaker uses a power action unit avoiding chattering even under unusual volume. Over-size magnet. We guarantee satisfaction. Cone diameter 9 in. In factory sealed carton. Shipping weight 6 lbs.

List Price \$10.00.  
**YOUR SPECIAL PRICE..... \$2.75**

## Utah Dynamic A.C. Power Speaker—Model 33A

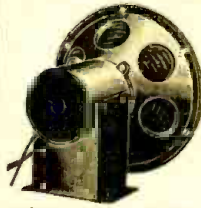

110-volt, 60-cycle A.C. light socket supply for field excitation using Westinghouse dry rectifier. 9 in. high, 9 1/2 in. wide, 7 1/2 in. deep. Speaker comes packed in wooden crate. Weight 19 lbs. It is one of the most powerful as well as best 9-inch cone.

Producers in the market.  
List Price \$50.00.  
**YOUR SPECIAL PRICE..... \$7.50**

## Peerless 15" 110 Volt D.C. Concert Dynamic Speaker



The largest and most powerful dynamic speaker model gives tremendous volume—deep and sonorous, as well as fully vibrant over entire musical register. Contains push-pull output transformer (adapts speaker to any receiver output) and two D.C. field coils, one 800 ohms and the other 4,000 ohms.

Ideal for use with Webster amplifier listed below. Shipping weight 25 lbs.  
List Price \$75.00.  
**YOUR SPECIAL PRICE..... \$16.95**

## R.C.A. Loud Speaker 103



A beautiful speaker in appearance. Superior in its ability to reproduce music and speech most faithfully. The frame and pedestal are mounted to resemble hand-carved oak, while the beautiful tapestry medallion conceals the mechanism and completes the decorative design of the

instrument. Magnetic unit Corrugated cone. Height 15 in., width 13 1/2 in., depth 6 1/2 in. In factory sealed carton. Shipping weight 14 lbs. List Price \$22.50.  
**YOUR SPECIAL PRICE..... \$5.20**

## R.C.A. Filter Condenser and Output Choke No. 8346

This unit has 7 condensers and an output choke. Condenser values include four 0.5-mfd., capacities and three 2-mfd. capacitors—total 8-mfd. Used in Radiola No. 60. Size 6 x 4 x 3 inches. Shipping weight 5 lbs. List Price \$16.50.



**YOUR SPECIAL PRICE..... \$5.75**

## R.C.A. Double Filter Chokes (No. 8336)

This heavy-duty, extremely strong, double filter choke can be used for all types of filter circuits, experimental work, power amplifiers, receivers, eliminators, power packs, converted sets, etc. Known as R.C.A. replacement part for all Radiola models, particularly Nos. 33, 17 and 18. Each choke D.C. resistance, 500 ohms. Connected in parallel, these double filter chokes have a rating of 30 Henries at 160 Mills; connected in series, 60 Henries at 80 Mills. Fully shielded in heavy metal case with special insulating compound. Size 5 1/2 x 3 1/2 x 2 1/2 inches. Shipping weight 6 lbs.



List Price \$10.05.  
**YOUR SPECIAL PRICE..... 95c**

## R.C.A. 600 Volt Replacement Condenser Block (No. 8333)

For Radiolas 18, 33 and 51. Over a half a million of these different types of Radiola receivers are on the market. Every serviceman needs these blocks, but they can of course be used for other purposes, such as experimental or converting battery sets for power. Size 3 1/2 x 2 1/2 x 3 1/2 inches. Shipping weight 4 lbs. List Price \$7.40.



**YOUR SPECIAL PRICE..... \$1.45**

## Earl Power Transformer

Make money re-winding the old battery set. This power transformer used in Earl Model 22 receiver supplies "A," "B," and "C" potentials for: two '27's (or screen - grid '24's), three '26's, two '71A's and one '30 rectifier; total current output of high-voltage winding at maximum output (about 200 volts) is 80 ma. High-voltage secondary, filament winding for '27's, and for '71A's are center-tapped. May be used in any number of combinations. Suitable resistors, a couple of 4-mf. filter condensers, two 30-henry chokes and by-pass condensers complete fine power pack. Size 3 1/2 x 3 x 2 1/2 inches. 16 long leads and full wiring directions. Shipping weight 5 lbs. List Price \$7.50.



**YOUR SPECIAL PRICE..... \$1.75**

## R.C.A. Filter Cond. No. 8289

This condenser unit of 6 condensers includes two 1.0-mfd., two 3.5-mfd., a 2-mfd. and a 3-mfd. condenser—total capacity 17-mfd. Used in Radiola No. 17 and Radiola No. 50. Size 6 x 4 x 3 inches. Shipping weight 4 1/2 lbs. List Price \$19.20.

**YOUR SPECIAL PRICE..... \$5.75**

## Loftin-White Direct Coupled 2-Stage Power Amplifier



A very fine phonograph or radio tuner amplifier. Gives auditorium volume! Uses one 224, one 245, one 280 tubes. 6 3/4 x 8 1/2 x 9 inches. Self-contained power supply — for 110 volt, 60 cycle, A.C. Shipping weight 20 lbs.

List Price \$35.00.  
**YOUR PRICE..... \$16.50**

## 2 1/2 Volt A.C. Fil. Transformer



Two windings, both center tapped. One "lights" six 227 or six 224 2 1/2-volt tubes, and the other lights two 245 tubes (not used with Webster amplifier). Total: 14 amps. For 110 volt, 60 cycle, A.C. Size 4 1/2 x 2 1/2 x 3 1/2 inches. Shipping weight 6 lbs.

List Price \$10.00.  
**YOUR SPECIAL PRICE..... \$2.75**

## 1 1/2-2 1/2-5 V. A.C. Transformer

Lights five 226, two 227 (or 224) and two 171 A.C. tubes. Permits conversion of battery sets to A.C. operation, using Raytheon type "B" eliminator. For 110 volts, 60 cycles, A.C. Shipping weight 5 lbs.

**YOUR SPECIAL PRICE..... \$3.95**

## Fred-Eisemann Block

Contains 1-4 mfd., 2-1 mfd., 2-1 mfd., 1-5 mfd., 1-2 mfd., 5 1/4 x 3 1/2 x 2 1/2 inches. Flexible leads. Shipping weight 6 lbs. **YOUR PRICE..... \$1.95**

## Webster Push-Pull Power Amplifier and "B" Supply



Uses two 226, two 210 and one 281 tubes! Super powerful PUSH-PULL amplifier, GIVES AUDITORIUM VOLUME! Also furnishes 110 volt D.C. speaker field voltage (A.C. speakers can also be used) and 15, 67, 90, 135 volts "B" current FOR USE AS PHONOGRAPH, SPEECH AND RADIO TUNER AMPLIFIER! 16 in. long, 10 1/2 in. wide, 6 1/2 in. high. Uses 2 1/2-volt A.C. filament transformer shown at left to supply "A" current to tubes in tuner, to which it will be coupled. FULLY GUARANTEED! For 110 volt, 60 cycle, A.C. Shipping weight 40 lbs. List Price \$100.00.

**YOUR SPECIAL PRICE..... \$20.25**

## Victor Push-Pull Input-Output Unit

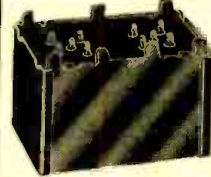

Housed in one metal case. For 171A, 215, 250 tubes. Electrically shielded—impregnated in dielectric sealing compound. Output matches moving coil on all dynamic speakers. Solder lug terminals. TREMENDOUS VALUE! Shipping weight 6 lbs.

**YOUR PRICE..... \$2.50**

## A.C. Phonograph Motor

SYNCHRONOUS—revolves EXACTLY 30 turns per minute despite any voltage variations. Most compact motor made—only 1 1/4 in. thick. mounts in any limited space. For 110 volt, 60 cycle, A.C. Complete with turntable. Shipping weight 10 lbs. List Price \$15.00.



**YOUR SPECIAL PRICE..... \$4.45**

## Patent "Phonovox" Pick-up



One of the best and most powerful electric phonograph pick-ups made. Balanced tone arm, unusually sensitive.

Shipping weight 7 lbs. **YOUR PRICE..... \$4.85**

## A-B-C Eliminators



Dispenses with all batteries—no new tubes required. "A" unit (booster) furnishes 6 volts at 2 1/2 amperes; "B-C" unit furnishes 180 volts (and up to 40 volts (lower plate voltages) and up to 40 volts (requires 280 rectifier tube. For all push-pull amp. receivers, or any type battery set. Shipping weight 12 lbs.

"A" UNIT..... \$11.45  
"B-C" UNIT, with 280 tube. Shipping weight 12 lbs. .... \$10.75

## Replacement Power-Pack Condenser Blocks



Exact duplicate, physical size, placement of connection terminals, and electrical specifications of original blocks. For Majestic 171 type receivers..... \$5.85

Shipping weight, all types, 7 lbs.

For Majestic 250 type receivers... \$5.85

For Majestic 245 type receivers... \$5.85

For Majestic "B" Eliminators... \$2.90

The above can be used with any similar power packs—fully guaranteed for ONE YEAR! (All other types can be supplied. Write for prices.)

## 245 A.C. Power Transformer



For five 224 (or five 227), two 245, one 280 A.C. tubes OR ANY COMBINATIONS OF 2 1/2-VOLT TUBES. All secondary windings CENTER TAPPED. 600-VOLT HIGH VOLTAGE SECONDARY. 75 WATT CAPACITY. Size 5 1/4 x 1 1/2 x 3 1/2 inches. For 110 volt, 60 cycle, A.C. Shipping weight 12 lbs.

List Price \$15.00.  
**YOUR SPECIAL PRICE..... \$4.45**

## 600 Volt Condenser Sections

Impregnated in pitch. Flexible lead terminals.  
5 mfd.....25c  
1. mfd.....30c  
2. mfd.....40c  
4. mfd.....60c

## Dry Electrolytic Condensers



Mount in any position! Guaranteed never to blow out! Remarkably compact and very inexpensive, permitting generous use of filtering systems. The greater the mfd. capacity employed, the less A.C. hum remains. 500 volt peak rating. Ideal for all 171A - 245 power packs—use two of each capacity desired for 250 power packs (1,000 volt peak thereby assured).

Mfd.	Num. Anodes	Diameter	Length	YOUR PRICE
1	1	3/4 in.	2 1/4 in.	28c
2	1	1 in.	2 1/2 in.	45c
4	1	1 1/4 in.	2 3/4 in.	85c
8	1	1 3/4 in.	4 1/4 in.	\$1.25
16	2	3 in.	4 1/4 in.	2.12
24	3	3 in.	4 1/4 in.	2.75
32	4	3 in.	4 1/4 in.	3.75

## GUARANTEED (6 MONTHS) "REXTRON" TUBES



Sold on a 6 month FREE REPLACEMENT GUARANTEE BASIS, IF THEY PROVE UNSATISFACTORY! All tubes are carefully meter-tested before shipment, and carefully packed. Do not confuse these HIGH QUALITY TUBES with any other "low priced" tubes—"Low Price" tubes are usually "seconds."

Choice of	Choice of	Choice of	Choice of
226	201A-112A	224	222
227	200A-199UX	245	210
171A	199UV-120	280	250
			281

\$1.00 each \$1.00 each \$1.00 each \$2.95 each



WE ARE A WHOLESALE HOUSE AND CANNOT ACCEPT ORDERS FOR LESS THAN \$3.00. If C. O. D. shipment is desired, please remit 20% remittance, which must accompany all orders; balance on delivery. If the full cash amount accompanies the order, you may deduct 2% discount. Send money order—check—U. S. stamps (any denominations).

**Radio Trading Co.**  
246 Fifth Avenue  
New York, N. Y.

Should you wish goods shipped by parcel post, be sure to include sufficient extra remittance for same. Any excess will be refunded.

We have no catalog—order from this page; you will find special offers from time to time in this magazine. Prompt shipments will be made.



# WE WILL NOT BE UNDERSOLD!

NATIONALLY ADVERTISED GOODS — IN ORIGINAL CONTAINERS — FULLY GUARANTEED

## WE ARE HEADQUARTERS FOR REPLACEMENT PARTS FOR ALL STANDARD SETS

### Thordarson 171 AC Power Transformer

For 5-226, 2-227, 2-171A, 1-280. The secondary windings are all center-tapped. High voltage winding gives ample voltage for any push-pull audio circuit, and sufficient voltage for all intermediate "B" requirements. Unusually well designed and constructed. Furnished with long flexible leads. For 110 volt. In lots of 6, \$15.00.

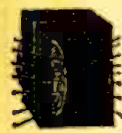

**\$2.75**

### Thordarson 245 AC Power Transformer

For all sets using 2 1/2 volt tubes—224, 227, 245 types. For 6-224 (or 227), 2-245, 1-280, or any other combinations. High voltage secondary furnishes 660 volts (330 volts across each section center tap). All filament secondaries are properly center tapped.



**\$3.45**

### Thordarson 250 AC Power Transformer

For all super-power auditorium amplifiers, transmitters, receiver power packs, etc. For 5-224 (or any combination of 224-227 tubes), 2-250, 2-281 (FULL WAVE) tubes, 1300 VOLT SECONDARY! All windings center tapped! For 110 volt, 60 cycle A. C. Lots of 6, \$29.75



**\$5.45**

### Thordarson 2 1/2 Volt AC Filament Transformer

TOTAL 16 amps! Two center windings. Both center tapped—one for 2-245, and other for any combination of 6-224 or 227 tubes. For 110 volt 60 cycle A. C. Lots of 6, \$21.50



**\$3.75**

### Sprague 245 Condenser Block

For any 245 type set power pack. Contains all necessary sections to adapt it for that purpose. Rated as high as 600 volts! Ideal for replacement purposes—or for new power packs! Lots of 6, \$17.00



**\$2.95**

For 171 Sets - **\$1.95**

### Radax Short Wave Set

Housed in fully shielded aluminum case, single, calibrated tuning dial. Uses precision plug-in coils (furnished) covering 10 to 220 meters! Fully assembled and wired. Requires 1-222 SCREEN GRID DETECTOR, 1-201A (1st A. F.) and 1-112 A (2nd A. F.) Reg. \$68.00.



**\$15.95**

Complete

"ROUND THE WORLD RECEPTION". Housed in fully shielded aluminum case, single, calibrated tuning dial. Uses precision plug-in coils (furnished) covering 10 to 220 meters! Fully assembled and wired. Requires 1-222 SCREEN GRID DETECTOR, 1-201A (1st A. F.) and 1-112 A (2nd A. F.) Reg. \$68.00.

### Original Replacement Condenser Blocks

For Majestic Super "B" Elim. **\$2.95**  
 For Majestic Master "B" Elim. **3.85**  
 For Majestic 171 Sets **5.88**  
 For Majestic 245 Sets **6.45**  
 For A-K No. 37 Sets (containing 2 chokes) **4.95**  
 For Freed Eiseeman Sets **1.95**  
 All of the above guaranteed ONE YEAR!  
 NOTE:—We can supply a block FOR ANY MAKE ELIMINATOR, OR POWER PACK—SHIP US YOUR DEFECTIVE BLOCK, for proper replacement thereof.

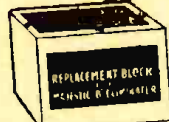

### R.C.A. AC Power Transformers

No. 8335. For Radiolas 33, 18, 17, 51. For 4-226, 1-227, 2-171A, 1-280. Properly center tapped. 600 Volt secondary **\$3.25**  
 No. 8472. For Radiolas 44, 46, 47. For 3-224, 1-245, 1-280. 660 volt secondary—all center tapped—**\$4.85**  
 No. 8333. Condenser Block and output choke, used in 33, 18, 17, 51 **\$1.50**  
 No. 8289. Filter Block. **\$5.85**  
 Total 14 mfd.  
 NOTE:—Complete line of RCA replacement parts in stock.



## SEND FOR OUR FREE CATALOG—THE OFFICIAL ORGAN OF THE RADIO TRADE

### Peerless 16" 110 Volt D.C. Dynamic Chassis

The Most powerful and most perfectly reproducing speaker made—Used in theatres, halls, homes, etc. For 250-245 or 171 Power Packs. Contains push-pull output transformer which perfectly matches Speaker to any receiver. Also contains two field coils—one is 800 ohms, and the other is 110 volt D.C. ohms. Plug into any power pack providing 90-120 volts D.C., such as the Webster described below. All smaller sizes in stock. Reg. \$100.00



**\$15.95**

### Build A Peerless 4 Screen Grid Tuner

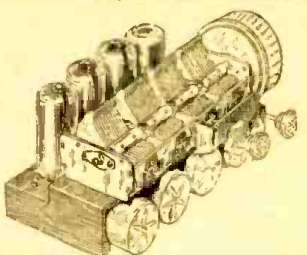

Detailed blue-print furnished. Can be used with ANY AMPLIFIER. COILS ARE INDIVIDUALLY SHIELDED, AS ARE THE TUBES. USES EITHER A 227 LINEAL POWER DETECTOR, OR A 224 SCREEN GRID DETECTOR! Condenser sections properly shielded and equipped with accurate and easily accessible compensators. REPLACE YOUR PRESENT TUNER SYSTEM WITH THIS 1931 FULLY IMPROVED AC TUNER. Uses 4-224, or 3-224, 1-227. COMPLETE SETS OF PARTS AS PURCHASED FROM THE REPRODUCER CORP. **\$14.95**

### Kolster K-6 Speaker



So realistic in reproduction it almost rivals a good dynamic, even though it is actually a magnet speaker! Will operate PERFECTLY with any receiver, using 171-245 or even 250 tubes. Never blasts—nor distorts! 12 1/2 inches high. Very attractive cabinet. Reg. \$35.00 **\$4.90**

### Webster 250 Push-Pull Power Amplifier and ABC Power Supply

Contains three audio stages—the third stage being PUSH-PULL, using 2-250 tubes (or 2-210 tubes). Connect to any radio tuner, or output (detector plate lead), or any phono, pick-up or microphone. "B" furnishes 45-67-90-135 volts. "C" furnishes 12 amps. of 2 1/2 volt current, and 2-227 (not 2-226!) 2-quires (or 2-110) AC tubes. (\$8.25 additional.) Reg. \$100.00



**\$29.80**

### What Every Battery Set Owner Has Been Seeking:

AN A. C. 245 PUSH-PULL TWO STAGE SUPER-POWER AMPLIFIER, AN A. C. ABC POWER SUPPLY, AND A 6 VOLT AUTOMATIC "A" SUPPLY FOR BATTERY SET TUNER! Imagine, you can convert any battery set into an A. C. set, WITHOUT ANY REWIRING, OR WITHOUT MAKING ANY CHANGES IN YOUR PRESENT SET! Five minutes after you have opened the parcel containing this instrument, you enter the EQUAL OF A 1931 A. C. RADIO SET. IN OPERATION! You just connect the detector plate lead in any battery set to the input post, on our unit, and DISCARD ANY PRESENT BATTERY EQUIPMENT, CHARGER, ELIMINATORS, ETC! NO NEW TUBES TO BUY, JUST KEEP USING YOUR PRESENT 6 VOLT BULBS IN YOUR TUNER. The audio stages in your tuner are not used, nor the tubes in those sockets. Instead, OUR AMPLIFIER, with self contained ABC power supply, (also furnishes all necessary "B" voltages to tuner) WILL GIVE YOU THE SAME REPRODUCTION AS ANY MODERN 1931 AC SET! There are thousands of battery set owners in your community, long awaiting this timely invention—OPPORTUNITY EVER OFFERED OUR CUSTOMERS! For 110 volt, 60 cycle A. C. COMPLETELY ASSEMBLED. Phonograph pick-up is connected to a 227 tube, reserved especially for this purpose! TUBES REQUIRED: 2-227, 2-245, 1-280. **\$24.95** (less tubes)  
 NOTE:—Also available, WITHOUT A VOLT D. C. "A" Supply, but WITH 12 amp. 2 1/2 VOLT AC FILAMENT SUPPLY. (FOR A. C. TUNER), and all "B" voltages, for tuner. **\$17.95**



### Loftin-White Direct Coupled 2 Stage Amplifier and ABC Power Supply



Auditorium volume! Perfect reproduction! Self-contained ABC power supply—also furnishes ABC current for 2 1/2 volt tubes used in any tuner, to which it is coupled. Very easily connected. Requires 1-224, 1-245, 1-280. Reg. \$35.00 **\$15.95**

### AC Synchronized Phono. Motor



Revolves exactly 78 turns per minute, despite any voltage fluctuations. Only 1 1/4 inches thick—most compact made! For 110 volts, 60 cycles A. C. With turntable **\$4.45**  
 Reg. \$35.00

### Radax Super 245 ABC Power Pack

An ideal power supply unit, for converting battery receivers for AC tubes, or as replacement with any AC set using 2 1/2 volt tubes, either 2-245 or 2-27's, with a pair of 245's in a push-pull amplifier. Contained in a durable and attractive metal can, with all ABC voltage terminals mounted on a bakelite strip fastened on the outside of the case. Furnishes 45, 67, 90, 135 and 250 volts. "B" current—choice 1 1/2, 2, 4 amps. 2 1/2 volts. "C" bias for two 245 tubes. FULLY GUARANTEED! Requires 280 rectifier for 110 volts, 60 cycle A. C. Reg. \$10.00 **\$12.85**



Thord. R-171 Compact **\$4.85**  
 Thord. R-210 Compact **\$6.95**  
 Thord. R-245 Compact **\$11.90**  
 (All Contain 2 Chokes)

### Build A Peerless 9 Tube Screen Grid AC Receiver

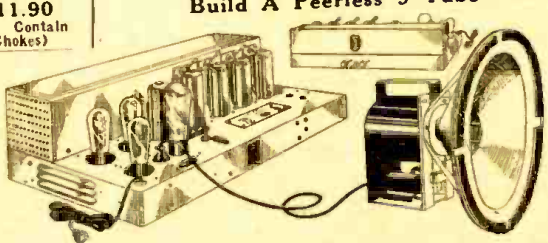

Complete parts—semi assembled. All holes in metal chassis are punched. Assembled by any novice in three hours. USES THREE SCREEN GRID TUBES! LINEAL POWER DETECTION! PUSH PULL 245 AMPLIFIER! PHONOGRAPH ATTACHMENT! RECEIPTABLE FOR SHIELDING WAVE SUPERHETERODYNE ATTACHMENTS! TUBE VOLTAGE REGULATOR! TOTALLY SHIELDED! IMMENSE POWER PACK! TONE CONTROL! Requires 3-224, 2-227, 2-245, 1-280 and CLARONEST VOLTAGE REGULATOR. Detailed blue-print furnished! COMPLETE SET OF PARTS, AS PURCHASED FROM THE REPRODUCER CORP. **\$22.50** (less speaker)  
 (Speaker \$6.95 extra) FULLY GUARANTEED!

## ORDER FROM THIS PAGE

AMALGAMATED PURCHASERS, INC. 142-R LIBERTY STREET NEW YORK CITY

NO ORDER ACCEPTED FOR LESS THAN \$3.00. WE ACCEPT CHECKS, MONEY ORDERS AND STAMPS IN ALL DENOMINATIONS. INCLUDE POSTAGE ALLOWANCE. ANY EXCESS REFUNDED. IN ABSENCE OF POSTAGE ALLOWANCE, SHIPMENT WILL GO FORWARD. EXPRESS COLLECT. C. O. D. SHIPMENTS REQUIRE 20% DEPOSIT REMITTANCE WITH ORDER.



# RADIO'S *Latest and Greatest*



## Get This 168 Page Catalog

### **EVERYTHING AT LOWEST WHOLESALE! PRICES**

### **You Never Saw SUCH VALUES!**

On every page of this remarkable Book of Bargains you will find items of interest—over 500 illustrations of the latest features in Radio receivers and equipment—sets, accessories, parts and kits.

### **Newest Improvements**

All the 1931 marvels of Radioland—1931 Screen Grid, Tone Control, A. C. Humless All-Electric Sets, Mantle Sets, Public Address, Phono-Combinations, Dynamic Speakers, Beautiful Consoles—as well as battery operated sets. Also the brand new Slot Machine Radio—a big money-maker for restaurants, hotels, stores and public places.

### **A Slaughter of Prices**

Old price standards are slashed to smithereens in our new quotations. The finest merchandise that skill can devise at lowest wholesale prices. We save you big money on any radio need.

At no time since the science of RADIO startled the world have you been able to secure such astounding values as the new Allied catalog brings you.

If you contemplate buying either a complete set or any single article of radio equipment, it will mean money in your pocket to have this 1931 book of wonderful radio values before you.

### **Our Buying Power**

alone brings you these amazing values. With resources of over three million dollars, we maintain an enviable position in the buying market. You reap the benefit.

### **Catalog is FREE**

Every buyer of radio merchandise should have this catalog, with its myriad of money-saving features. Send for it today.



## **ALLIED RADIO CORPORATION**

**711 W. Lake St. Dept. R-2 Chicago**

You Pay Only  
**\$48<sup>25</sup>**  
for this  
**\$110<sup>00</sup> VALUE**



# EARN BIGGER PAY in RADIO

## Be a *Certified* RADIO-TRICIAN



### \$1800 to \$5000 a Year

Broadcasting stations need men continually for jobs that pay \$1,800 to \$5,000 a year to Radio engineers, operators and station managers. Many men who completed my course are now earning big money in this field. I will train you to do as well or even better.



### World-Wide Travel and Good Pay Plus Expenses

Shipping companies use hundreds of operators and give them world-wide travel with practically all expenses paid and a good salary besides. In this fascinating field, too, my graduates are making good. My Employment Department receives many requests every year for "Sea-operators". Will I soon have the pleasure of recommending you?



### \$75 to \$200 a Week

Talking Movies wouldn't be possible without Radio. The good men employed in making and showing talking pictures must know the Radio I include in my course. Salaries range as high as \$75 to \$200 a week.

## I'll Train You Inexpensively at Home in Your Spare Time



J. E. Smith  
President

Send for my free, 64-page book, "Rich Rewards in Radio". Get the facts on the big-money opportunities this growing industry offers trained men. Find out how quickly you can learn at home in your spare time to earn real money in Radio. My amazingly simple 50-50 home-study training is the secret! It is the *only* training that enables you to become a *Certified* RADIO-TRICIAN.

### Many Earn \$50 to \$100 a Week

Many of my graduates are now making \$50 to \$100 a week in responsible Radio jobs. After completing my training you, too, should earn as good or even better pay—for the opportunities in Radio are growing greater every year. I train you for all branches of Radio—manufacturing, selling, servicing sets, a spare time or full time business for yourself, operating on board ship or in a broadcasting station—and many other lines, including Television and Talking Movies. My course is easy to understand, even for those whose education ended in the grammar grades. And no wonder!—it is the result of sixteen years' experience in training men and young men at home in their spare time to become Radio experts.

### Many Earn \$200 to \$1,000 in Spare Time While Learning

You stay right at home, hold your present job, and learn in your spare time. I teach you to begin making extra money on the side shortly after you enroll. My 50-50 practical method makes this possible. I give you eight big laboratory outfits and show you how to build and service practically every type of receiving set made. Many of my students earn \$10, \$20, \$30 a week *extra* while learning. Why not you? You don't risk a penny when you enroll with me. I back my course with a signed agreement to refund every cent of your money if, after completion, you are not satisfied with the Lesson and Instruction Service I give you.

### Send for My Free Book

See for yourself exactly what Radio offers you and what I offer you in Radio training. Send for my valuable free book. It has put hundreds of fellows on the road to big pay in Radio. Mail the coupon for your free copy NOW! J. E. Smith, President, Dept. O N Y National Radio Institute, Washington, D. C.



### Television

Television is a coming field of amazing opportunities. I'll get you ready for it now so you can get in on the ground floor when it is put into practical use.



### Aircraft Radio

Aircraft Radio is coming to the front fast. Airports and airplanes are being Radio Equipped. Get one of these thrilling, fascinating jobs—through N. R. I. I will show you the way to do it.



### \$50 to \$100 a Week

There is nothing like being the "boss" in a profitable full time or spare time business of your own. A large number of my men are now making from \$50 to \$100 a week selling and servicing Radio sets in their neighborhoods. Many started their business while taking my course and earned \$50 to \$1,000 even before graduating.

## Your Choice of 5 New Advanced Courses if You Enroll Now

My training not only gives you a thorough knowledge of Radio—all you need to get and hold a good job—but, in addition, you may take any one of my new advanced courses, without extra charge. They are Television, Aircraft Radio, Broadcasting, Commercial and Ship Radio Stations, Sound Pictures and Public Address Systems, and Advanced Radio Servicing and Merchandising. You won't be a "one job" man when you finish my training. You'll know how to handle a job in any one of Radio's 20 different branches of opportunity. Send for my free book now.



### \$800 in Spare Time

"Money could not pay for what I got out of your course. I did not know a single thing about Radio before I enrolled but I have made \$800 in my spare time, although my work keeps me away from home from 6:00 a. m. to 7:30 p. m. Every word I ever read about your course I have found true." Milton L. Leiby, Jr., Tupon, La.



### Salary Three Times Larger

"Before I completed your course I went to work for a Radio dealer. Now I am Assistant Service Manager of the Sparks-Withington Company. My salary is three times what it was before taking your course. I could not have obtained this position without it. I owe my success to N. R. I. training." H. A. Wilmoth, Sparkes-Withington Co., Jackson, Mich.

**FREE** 64 PAGE BOOK of FACTS and PHOTOS



## MAIL COUPON NOW

J. E. SMITH, President, Dept. O N Y  
National Radio Institute,  
Washington, D. C.

Dear Mr. Smith: Send me your free book "Rich Rewards in Radio", giving full information on the big-money opportunities in Radio and your famous 50-50 method of training men in spare time to become Certified Radio-Tricians. I understand this places me under no obligation and that no salesman will call.

Name.....  
Address.....  
City.....  
Present Occupation.....